

AP-ART

The Sculptural Art That Comes Apart

Stewart T. Coffin

First release of revised edition, December 2000



Introduction

This publication consists of three parts. Part 1 contains some background information and commentary on my puzzle craft not included in any of my previous publications. Part 2 is essentially a chronological listing and description of my AP-ART creations starting at the beginning in 1968 and continuing up to the date of publication. Part 3 contains an appendix (i.e. everything not included in the first two parts). The Puzzle Index is an alphabetical index of all serially numbered puzzles. The Color Plates contain photographs of most of the puzzles.

A preliminary edition of this publication was hastily put together in time for distribution at the International Puzzle Collector's Party (IPP-20) at Los Angeles in August 2000. This revised edition contains a few corrections and much new material. It is anticipated that further revisions will be made.

This is by no means a how-to-do-it manual. Even so, the descriptions given here are probably sufficient for a skilled woodworker to be able to duplicate many of the designs, but only if used in conjunction with the three books of mine that are listed in Part 1. Furthermore, this assumes that you start with the simpler designs and work through them progressively to the more complicated ones. That is the way I did it.

It is not necessary to ask my permission to manufacture and sell any of the designs listed here. I encourage others to become involved in this rewarding and fascinating craft. Unless otherwise indicated, all of these designs are my own creations. Yet you might say that is only partly true, for they are all based on ideas that have evolved over centuries, their origins fading away into the dim and distant past. As far as I am concerned, they can all be regarded as in the public domain.

Part 1 - Background and Commentary

How It All Began

The spring of 1968 found me busily engaged in the design and manufacture of fiberglass canoes, kayaks, and related equipment, which I had been doing since 1961 after quitting electrical engineering. I was finding the noxious fumes of the fiberglass resins increasingly unpleasant. One fateful day, recalling an illustration I had seen in the marvelous book *Mathematical Snapshots* by Hugo Steinhaus, which my father had given to me way back in 1950, I started playing around with a cluster of 12 triangular sticks. I have always been keenly interested in mathematical and geometrical recreations. This soon led to a variation with notched hexagonal rods that made an intriguing interlocking assembly.

Back then I was much more adept with fiberglass resins rather than woodworking, so I decided to cast a few of these novelties in epoxy. By the way, the original pattern for molding these pieces was machined accurately from steel by our neighbor, Fred Wilfert, an expert machinist. Our three daughters, then ages 6, 7, and 9, took an interest, especially Abbie, the oldest. Evidently she took one of these novelties to school one day to show her friends, and somehow it also came to the attention of the Town of Lincoln children's librarian Heddie Kent. That led in turn, through a complicated series of connections now forgotten, to my being put in touch with a man in the neighboring town of Concord, Thomas Atwater, whose unusual profession was as business agent for puzzle and game inventors.

Soon, through the efforts of my newfound business agent, 3M Company indicated an interest in adding my *Hectix* (#25) to the new line of puzzles in their stationery division, and a contract was drawn up for them to be manufactured in injection molded styrene. On the strength of this, and especially the generous advance royalty, I decided to liquidate my stinky fiberglass boat business and embark on this new enterprise of inventing geometrical recreations.

The Cast Epoxy and Plastic Phase

I spent most of 1970 experimenting with other geometrical models and casting them in epoxy. Some of these are described and illustrated later in this publication. My agent had almost no success in licensing any of them, and in looking back at them now I am struck by how poorly conceived most of them really were. One exception was my *Snowflake* (#3) puzzle, which had limited success. The Sam Span Company cast a version of it in polyester resin (with badly misshapen pieces). It came with a molded styrene base and 10-page instruction booklet. About 500 of these were sold by the Museum of Modern Art in New York. The only other exceptions were my *Frantix* (#9-A) and the Geo-Logic series, both of which are described in Part 2

An amusing situation occurred in the summer of 1970. The *Hectix* (#25) Puzzle was being manufactured by Nylon Products in nearby Clinton, Mass. The individual pieces were spewing out of their high speed injection molding machines by the tens of thousands, but then they had to be assembled, and doing this with union chemical workers proved to be not only slow but very expensive. An emergency meeting was called in Clinton. After much head scratching, I told them to ship all parts to my plant in Lincoln and we would assemble them for 4 cents each. Unknown to them, my *plant* was to consist of benches set up on our lawn, with our three children doing the assembly. I paid them 2 cents per puzzle and pocketed the difference. Soon some of their neighborhood playmates also got in on this bonanza. Some of them assembled about 100 units per hour. Abbie, then age 10, was clocked at 11 seconds. We assembled 20,000 puzzles in about two weeks until our contract sadly came to an end. I don't know where they were assembled after that.

There is an interesting sequel to this story. I noticed that some of our better assemblers, Abbie especially, were after a while doing the assembly more by feel without even looking. Later that year we were invited to do a puzzle program on the Tom Colton Show, Channel 22, West Springfield. For the finale of our half-hour show, Abbie was to assemble the Hectix blindfolded. This, by the way, was back

when such shows were live, not tape-recorded as they are these days. So we practiced until she could do it consistently in one minute. On the actual show we allowed two minutes with our fingers crossed, but she came through with time to spare. I wish now that we had a recording.

I am sometimes asked if I have patented any of my designs. I do not think that puzzle patents are a very good idea, and the following experience may help to explain why. I hold two puzzle patents, and the only reason for this is that they were licensed for mass production, and the manufacturer insisted on the patents (and paid for them). They were drawn up by patent lawyers and written in such convoluted language that I hardly recognized my own designs. (It was explained to me that this was done deliberately, but don't ask me why!) After the *Hectix* (#25) puzzle had been on the market for a while, I learned through my agent that we were being threatened with a lawsuit for patent infringement. I had already conducted my own patent search, and on the basis of that we concluded that the patent in question was probably of Sanson, 1968 - a more complicated assembly of 24 notched hexagonal rods. After we prepared all sorts of arguments why my *Hectix* (#25) was different, we learned that the threat was instead coming from a professor of architecture whose patent on structural members did not even mention puzzles. I was told that this was common practice among patent attorneys just fishing for a settlement, and we ignored it. Ironically, later I discovered that the basic idea for the *Hectix* (#25) puzzle had been discovered a few years earlier and independently by Bill Cutler, a very capable mathematician and puzzle designer, but unfortunately for him he never carried it through to successful production.

Incidentally, when my *Hectix* (#25) design was later copied and manufactured by other puzzle companies without permission, I asked 3M Company if they intended to enforce our patent. I was told that this was almost never done because of the cost of litigation, which could run as high as half a million dollars. It seems that only the lawyers come out ahead in this game. By late 1970, it was becoming clear that the only sure way to earn a living in this business was to start making and selling my own products. I wasted much effort trying to find some practical way to cast the pieces in epoxy. When I finally came to the realization that this was a bad idea, I switched to woodworking.

The Sculptural Art That Comes Apart

In the fall of 1970, I had the good fortune to be invited to participate in an arts and crafts festival at the DeCordova Museum, located nearby in my hometown of Lincoln, Mass. It was here that the term *AP-ART* originated. It seems that one of the other exhibitors at the show took his work very seriously. When he found my children and me, purveyors of wooden "toys" setting up right next to his exhibit of abstract sculpture, he displayed his strong displeasure and asked, "What's that!" That was back in the days when Op Art and Pop Art were in vogue, so I jokingly replied AP-ART. He found it not very funny and objected to our being even in the same room with him. So, to our good fortune, we were banished to the more folksy and friendly outdoor craft area, which happily introduced us to other craftsmen and marked the beginning of our craft fair years. That memorable phase of our family enterprise, all too brief as it was, kept us all entertained and was a valuable experience for our three little helpers. It also brought us in direct contact with the public and served as a valuable learning experience for me.

By early 1971 I was beginning to make and sell my unique line of geometrical woodcraft products. Describing to others what I did for work always was a problem. If I said that I created puzzles, they would usually ask "jigsaw or crossword?" I soon learned not to follow that up with any attempt to describe them as three-dimensional puzzles because I dreaded being asked almost invariably, "Oh, do you make Rubik's Cube?" It hurt every time I was asked that. (And I still am asked!) Consequently, for a long time I deliberately avoided the use of the word *puzzle* in describing my work. Never again will I use it in the title of a book. Hence the renewed emphasis on my fanciful but fitting slogan "AP-ART, the sculptural art that comes apart."

The Craft Fair Years

From 1971 to 1975, most of my sales were at craft fairs. Usually our whole family was involved - my wife Jane and our three little girls, Abbie, Tammy, and Margie. The most important of these was the annual American Crafts Council fair, first in Bennington and later Rhinebeck, which was both wholesale and retail. Soon I had more business that I could possibly handle and was turning customers away. The main reason for this was that practically no one else was in this line of woodcraft, and certainly not as a full-time business. Even many years later this was still the case.

The wholesale business was more profitable of course because of the volume, but I much preferred the retail sales because it brought us into direct contact with the public. I recall many amusing incidents. One passer-by, probably a psychiatrist, stared at our large display of perplexing polyhedral dissections and asked, "Did you have an unhappy childhood?" Later that was used as the name for one of my more puzzling creations. More than one customer asked if I had a puzzle that would drive someone completely out of their mind. I assumed they were targeting their spouse, and I would remark to Jane that perhaps we should check our liability insurance.

We had one act that we used over and over. Usually my *Jupiter* (#7) puzzle served as the centerpiece of our display. It looks a lot more confusing than it really is. If you toss it up with a slight spin it flies apart into a jumbled heap of 12 pieces. I would remark that anyone who could put it back together could have it. No adults would ever try. In the meantime, our youngest, Margie, would be planted in the gathering crowd and would work her way to the front. You can guess the rest. The audience loved it.

Most of our retail sales at craft fairs were to customers who were buying gifts for someone else, and I knew that they were nearly always for adults. I always regretted that so few were for children, but the cost was a factor. We did have one low priced novelty that we called the *Buttonhole Puzzle* (#45). Not my idea but an old favorite, it is just a stick and loop of cord that you attach to someone's clothing like a price tag. We made them from wood scrap using about 50 different kinds of exotic woods. My kids sold them for 25 cents each, often after attaching them to the victim's clothing. Sometimes we would be told years later that they were still on!

Buttons and Beads

In another attempt to come up with a low cost product that children could afford, in 1972 I turned my attention to topological puzzles, which typically use beads and cord with no close tolerances required. One of these was my *Sleeper Stopper* (#44) puzzle. Since I could not find any supply of high quality wooden beads, I decided to make my own. The machine that I devised to make them was basically a rapidly rotating 8-inch abrasive disk at the bottom of a round drum. Three-quarter-inch rosewood cubes with holes already drilled were loaded into it 100 at a time, and the abrasive was progressed from coarse to fine, and finally to buffing with wax. They came out rounded and shining like gemstones.

Soon customers began asking if they could buy just the beads. I made a larger bead mill with 12-inch disk and we turned them out by the thousands in various exotic hardwoods. The demand was phenomenal. At craft fairs we filled large wooden bowls with beads. People couldn't resist the urge to run their fingers through them, much the same way you play with sand at the beach. I devised a semi-automatic machine for drilling the holes, and turned over much of the operation to my kids. We added buttons to the line, and then pendants and earrings made with colorful laminated woods.

By 1975 we were filling so many orders for these that there was little time for making wooden puzzles. I began thinking that maybe it was time to return to more creative endeavors. But then an unemployed mechanical engineer named Laurie Grob who lived nearby, and whose wife was one of our button customers, came up with the idea of a key ring with a fancy wooden part that could be made using my bead machine. He had also located a company that was interested in purchasing them in very large quantity. We made an even larger mill using my wife's old washing machine, and we spent all of 1976 turning these out by the tens of thousands in various fancy woods. When that contract finally ran out,

Laurie bought out my half of the business and moved to New Hampshire, where he improved the whole process and started a successful button business. Last I knew, he was still at it. I happily returned to making wooden puzzles.

Museum Exhibits

Over the years, my associates and I have participated in a number of puzzle exhibits where the theme was just to display the various objects to be viewed by the public, usually in glass cases. The obvious objection to this is that mechanical puzzles are by definition designed to be manipulated. Take that away and what is left? Most polyhedral dissection puzzles do have the feature of being attractive to look at when assembled, especially when made with colorful exotic woods finely finished. But that can be both an advantage and disadvantage. I soon discovered that some customers were acquiring mine just to look at, without ever taking them apart. Sometimes I would even get a call from one of them exclaiming that some unruly visitor had taken one apart, and would I please send directions for putting it back together.

I will admit that when I first started making polyhedral dissection models, I too was fascinated by the way that geometrical solids fit together in space and the interesting shapes that resulted. Many of my early designs were little more than that - sculptural art that came apart. Later on, many other novel design aspects came into play, none of which could be appreciated or enjoyed by just admiring the assembled puzzle. I would often use plain hardwoods rather than colorful exotic woods in my work so that the sculptural features, which were really incidental, would detract less from all the other more important creative aspects that went into the design.

Again we come back to the limitations of puzzle exhibits. Some of us have tried hands-on puzzle shows with limited success. For the general public, the puzzles need to be very simple ones. Even so, you can soon end up with a pile of puzzle pieces unless there are many helpful hands around to reassemble them. Most museums don't have that kind of help available.

Books

Given the limitations of puzzle exhibits or museum collections, and the impossibility of producing enough to supply the public demand, perhaps the next best alternative is to be found in illustrating and publishing. Such books are now coming out like never before.

My first book, *Puzzle Craft*, was begun in 1974 as a newsletter of limited circulation having to do with mechanical puzzles in general, especially those that could be made in the classroom or workshop. In 1978, the various issues were assembled into a booklet. Later, more chapters were added, and it was published as a book of sorts. A revised and improved edition was published in 1985. Minor revisions continued to be made until its final printing in November 1991. In all, about 2500 copies of *Puzzle Craft* 1985 were printed. In 1986, Oxford University Press became interested in publishing something along the lines of my *Puzzle Craft* to be included in their Recreations in Mathematics series. This involved a whole new approach and complete rewrite with much more material included. That book, *The Puzzling World of Polyhedral Dissections*, came out in hardcover in 1990 and in paperback in 1991. About 1800 of the hardcover were printed, and probably a few thousand of the paperback (I was never sure). They both sold out within months, never to be reprinted by Oxford, for reasons which to this day remain a complete mystery.

Since I continued to receive requests for my old *Puzzle Craft* (1985), and because there was much overlap between it and the Oxford book, in 1992 I came out with a completely new edition of *Puzzle Craft*. It emphasized woodworking, whereas the Oxford book was more to do with geometrical recreations. In 1998, *The Puzzling World of Polyhedral Dissections* was made available at the *Puzzle World* web site and it, along with both versions of *Puzzle Craft* are available for purchase on CD-ROM at the Puzzle World Store or at amazon.com. To save space and avoid duplication, they will be referred to frequently in this publication and abbreviated as *PC'85*, *PWPD*, and *PC'92*

In addition to the above, I should mention some of the other related printed matter that I have disseminated:

From the start in 1968, I have kept records of my designs on file. Since names can be confusing (especially mine!), in 1970 I started numbering them as well. In 1985, I adopted a revised numbering system that I still use. In 1993, thanks to this amazing computer I'm using, I began making this list available as *Serial Listing of AP-ART Puzzles Produced and Sold*. It is updated yearly or sometimes even monthly. This present publication can be thought of as an expanded and much more detailed version of that list.

My numerical serial listing of designs described above is approximately chronological. However, since I have often used a letter suffix for a new modification of a previous design, therein is a departure from chronological. This could create a problem if loose-leaf additions to this publication are to be made. Therefore, henceforth I am revising my numbering of designs to make them strictly chronological as of January 1998

An explanatory printed sheet that may also occasionally include the solution accompanies many of my designs. Since 1993, an up-to-date listing of all these have been available as *Serial List of AP-ART Instructions, Descriptions, and Other Printed Matter*. The most recent version of this list is included in the appendix of this publication.

Part 2 - Complete List of AP-ART Designs

Before starting this listing in numerical order, for the sake of completeness I will insert a brief mention of those that predate the list or have been omitted for various reasons that should in most cases be obvious.

The first puzzles that I made were of the common jigsaw variety, when I was barely old enough to dissect scraps of plywood with a coping saw. From earliest childhood, I had a fascination for all things mechanical. My parents were very tolerant of my urge to take apart old appliances and machinery (later radios and electronic equipment), and soon I acquired a knack at repairing them. My father was an early pioneer in both scientific plant photography and pictorial nature photography, but he soon realized the futility of encouraging me to follow in his accomplished footsteps. He plied me with books and magazines on all the things I loved - mechanical, scientific, and mathematical. There was never the slightest question but that I would study engineering in college.

As a carry-over from model airplane days, I had some solid blocks of balsa wood. With these, I was inspired to create some three-dimensional jigsaw puzzles. These probably date from around 1946, since you could not get much balsa wood during World War II.

In that wonderful 1950 book already mentioned, *Mathematical Snapshots* by Steinhaus, I remember being especially fascinated by the rhombic dodecahedron and its various spatial properties. This must have remained dormant in the back of my mind until reemerging two decades later. That book also described a simple 3x3x3 cubic dissection called *Mikusinski's Cube*, which sparked my interest in cubic dissections.

The first original design for which I have any record is a 7-piece 4x4x4 cubic dissection called *Seven Block*. It was designed around 1958 while I was working at M. I. T. Lincoln Laboratory. I include it so that you can see progress has been made since then. Several of us at the Lab were interested in mathematical recreations, especially fellow electrical engineer Gus O'Brien. (It was he who first introduced me to the simple but intriguing six-piece first stellation of the rhombic dodecahedron.) I created the *Seven Block* and made one for Gus to puzzle over, but he quickly solved it. I made only that one. It is now in a collection in England.

As previously explained, for a while before the woodcraft began, I tinkered with experimental models cast in epoxy. The following were all created between 1968 and 1970

One of the first was *Spinner*, consisting of 6 identically shaped pieces in 3 colors, 2 of each. An injection-molded styrene version of this was later produced by Skor-Mor in their Geo-Logic series as *Tauri*. There was also a 4-color version in which each piece was of 2 halves of different color bonded together, to be assembled in color symmetry. Only about a dozen *Spinners* were cast.

The consisted of 12 nearly identical Z-shaped pieces, likewise cast in multicolor, which assembled to form a truncated rhombic dodecahedron. Only a few of this uninteresting design were cast.

Prism consisted of 6 identical pieces, cast in 3 colors, which assembled to form 3 intersecting square prisms. (This was later the basis for the *Seven Woods* (#42). Only a few of this mundane design were cast.

Pluto was a slightly more interesting version of Prism, in which each piece had a shoulder at one end, with assembled end faces slightly octagonal rather than square, and only one axis of assembly. Only a few were cast.

Octo was similar to *Prism* except that each piece was dissected longitudinally, making 12 pieces. It likewise used 4 colors with associated color symmetry problems. It was an exercise in dexterity to assemble. One version had a split piece for easier assembly. The assembled shape suggested an octahedron. Only a few were cast, but a modified version later led to the baffling *Three Pairs* (#27)

Four Color Cube consisted of 12 cast pieces, 3 of each color, which were to be assembled into a cube with 4 colors on each face. There was also a slightly more interesting version in which the pieces were joined in pairs to make 6 bicolor pieces. Only a few were cast.

Four Color Octahedron was similar to the **Four Color Cube** described on the previous page except octahedral when assembled, with likewise 12-piece and six-piece versions. Only a few were cast.

Tetrahedron was similar in principle to **Prism** except that the assembled shape was tetrahedral. It later became the basis for the injection-molded **Cetus**, produced by Skor-Mor in their Geo-Logic series.

There were many other experimental few-of-a-kind models cast during this phase and on into 1971, mostly not recorded. Some of them became the models for other "puzzles" in the Skor-Mor Geo-Logic series, such as **Nova**, **Spirus**, and **Uni**. There was one, **Double Star**, that could be assembled inside-out to form two different geometrical solids, but the Skor-Mor version was so misshapen as to be nearly useless.

One of the problems with the Skor-Mor series was that, in order to economize on mold costs, the manufacturer insisted on only puzzles with six identical pieces. In that way, a multi-cavity mold could produce several different puzzles at the same time. There is only so much you can do with six identical pieces. Another problem was that the pieces had to be "cored out," meaning that they consisted entirely of thin walls in order to cool faster in the mold and speed up the mold cycle. I wish now that they had never been made.

The **Hectix** (#25) puzzle, on the other hand, was solid .75-inch hexagonal. This was achieved by including a *blowing agent* in the styrene and a slower mold cycle, increasing the cost. A lot of this technology was new to the molder, and there were problems with burned or misshapen pieces, some of which were never completely corrected. The discoloration from heat was especially bad because of the ugly off-white color that the manufacturer chose. Our Agreement called for it to be made in four contrasting colors - red, yellow, green, and blue - but they never did it that way. I wish now that it had never been made in plastic. A wooden version would have been better.

As I mentioned in Part 1, for a while in 1970 I even experimented with setting up a production line myself casting puzzle pieces in epoxy. In looking back now, that seems so totally impractical that I can only wonder what I could have been thinking. One problem never overcome was that the RTV rubber molds, which were a lot of work to make, deteriorated rapidly after only a few cycles. The whole process was slow and messy, and most important, the finished product was not very attractive. And so I switched to wood, and the remainder of this publication is devoted to that phase of my work.

Again simply for the sake of being complete, before proceeding to the numerical listing, I will briefly describe just a few of the early attempts in wood which never made it into production:

OCC-Wood consists of 3 plywood pieces in the shapes of O-C-C, plus 2 small cubic blocks. They assemble easily into a familiar burr shape with the blocks inside, and the problem is to have the blocks fall into position to permit disassembly. Without the cubic blocks, it is a familiar old novelty published in many books. Only a few were made around 1973

Rec-Tangle also consists of 3 pieces in the O-C-C shape as above, but this time of glued up pieces, with a hole in one piece and a dowel loose inside. The first step of disassembly is to shake the dowel into the hole, which can be made as easy or hard as one wishes by the size and shape of the dowel and hole. Four more steps are required to disassemble. There is also a modified version in which the O piece is split into 2 burr-like pieces. Only a few were made around 1973

Wunder Bar consists of 6 pieces which fit together to form a cubic lattice. There are 4 types of pieces - W, X, Y, Y, Z, Z. Each piece is made up of three 1x1x5 sticks joined together. W and X are mirror image, likewise Y and Z. The diagram shows the design. There are 4 distinct mechanical solutions, but by using

multi-colored woods and requiring color symmetry, the number of solutions can be reduced. Only a few were made in 1973

Interlocking Checkerboard consists of 8 pieces which fit together 2 different ways to form (guess what!) an interlocking checkerboard (1973). Probably none were made.

Cube Brute consists of 24 identical burr pieces that interlock to form a symmetrical cubic-shaped assembly. A 16-piece square assembly is also possible. A couple sets were made in 1973. Pentangle came up with this independently around the same time, sold as their **Woodchuck Puzzle**. I also proposed a set to be called **TWIS-T**, in which 16 pieces are bonded together into 8 T-shaped pairs. In yet another variation, **RUFTY**, the remaining 8 pieces are also bonded together in-line. Multicolored pieces with color symmetry solutions were also proposed. Possibly a few of each were made, all in 1973

Mosaic is an 8-piece dissection of a 4x4x4 cube, designed in 1979. I must have made at least one, but have no record. The one known solution is shown here, but perhaps there are others. It is almost serially interlocking. An improved version became **Convolution** (#30)

In the same vein as the above, here is one with no name which appears in my notes for 1979. It is a six-piece 4x4x3 dissection with the capability of being made with eighteen 1x1x2 blocks and twelve 1x1x1 blocks of colorful woods such that symmetrical patterns appear on all faces. It is non-interlocking, so a box or tray might be used to retain it. Must have made one.

Triful was designed in 1973 for production in plastic, and a few models made of colored wood, but it was never produced. It consisted essentially of 12 triangular sticks with end blocks added, in 4 colors, 3 of each. Four pieces, one of each color, were split in two to permit assembly. Then a wooden version was designed around 1975 that used 4 sliding key pieces instead of split pieces, but only one or two were made. Much later this design was resurrected to become the basis for **Isosceles** (#101) and **Iso-Prism** (#101-A). See also **Notched Rhombic Sticks** in *PWPD*, pp. 136-37.

As some of the above entries indicate, I have ransacked my records to include everything in this comprehensive listing of AP-ART, no matter how mundane or obscure. There were many others that were never recorded and are now lost and forgotten. A few more may turn up from time to time, and if so I will add them later on as a supplement.

I am not including in this publication any of my admittedly feeble attempts at inventing games, such as **Arc-Tic**, and **Hebee-Shebee**, as they do not fit my concept of AP-ART. For the same reason, I omit topological amusements such as **Lamplighter**, **Liberty Bell**, **Bottleneck**, **Sleeper-Stopper**, **Super Sleeper-Stopper**, and **Figure Eight**, most of which are described in *PC*'85.

Now on to the numbered designs. I have tried to indicate the year designed, published, or first made, when known. The first illustrated brochure I put out was in 1970, and the last in 1990. I have also indicated the approximate number made, but only up to around 1990, after which the quantities decline to the level of a retirement hobby activity.

1. **Ortho-Cube**. A 12-piece dissection of a 5x5x5 cube that is not quite solid, 3 kinds of pieces, 4 of each. Symmetrical and not difficult. This early version, which appeared on my first brochure in 1970, was made of .875-inch square birch stock. About 20 made in 1970.

1-A. **The Cube**. Same as **Ortho-Cube** (#1) but made of .75-inch stock in contrasting fancy woods. By using 1x1x3 blocks, symmetrical colorful patterns appear on all faces. Appeared on 1971 brochure. About 100 made, 1971-1972.

Pentangle later made this design as their **Wookey Hole**.

2. **Pentablock**. The familiar set of 12 solid pentominoes in a 3x4x5 box. Not my design. This one made of .875-inch birch stock. Appeared on 1970 brochure. About 20 made. See *PWPD*, pp. 46-47 and *PC*'85, p. 30.

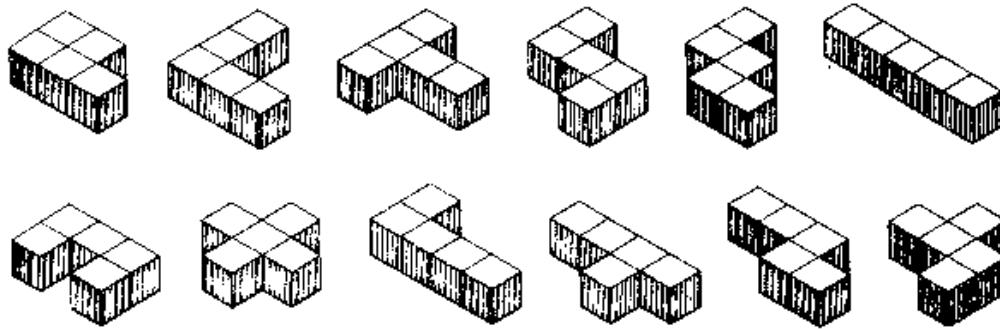

2-A. **Pentablock**. Slightly improved version of **Pentablock** (#2), made of .75-inch hardwood stock in a Plexiglas box. Appeared on 1975 brochure. About 10 made.

2-B. **Pentacube**. An improved version of the **Pentablock** (#2-A), same size, but of 12 contrasting fancy woods colorfully combined in the given solution, with a box of blue mahoe. Appeared on 1977 brochure. About 20 made.

3. **Snowflake**. Ten flat pieces made of 37 hexagons joined different ways assemble on hexagonal tray to form a Snowflake or Hexagon. Other problem shapes shown in booklet. The first version, which appeared on 1970 brochure, was of cast thermosetting resin. About 50 made. See *PC*'85, pp. 25-27, *PWPD*, pp. 39-40, and *PC*'92, pp. 16-19.

The next version was one made by Span-Atwater of cast polyester resin. They made about 500, 1972-1973. Came with 10-page booklet with 49 problems, as did those which follow.

A wooden version is mentioned on my 1977 brochure, but I don't think many were made. The next version was of cast Hydrastone pieces (shown in thumbnail) using surplus Span-Atwater molded styrene bases. Appeared on 1978, 1979, 1981, 1984, and 1985 brochures. About 100 made.

The next version was in fancy wood with plywood base and cover. About 10 made in 1986

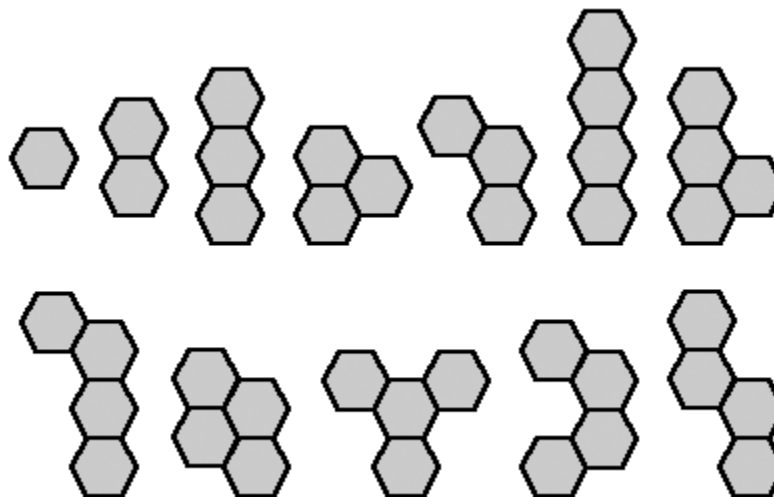

The next version was in thin birch plywood cut by Jim Ayer with a water jet, with molded styrene base. Appeared on 1990 brochure. About 30 made. The next version was in plastic foam, made and sold by Binary Arts around 1993. The most recent version was laser-cut by Walter Hoppe.

Note: All of these versions except the last one were the same scale - .75-inch hexagons.

4. **Sirius** (aka **Diagonal Star**). The familiar six-piece first stellation of the rhombic dodecahedron. Not my idea - in the public domain. See *PC*'85, p. 41, *PWPD*, pp. 75-78, and *PC*'92, pp. 37-38. This version made of glued up pieces in 3 contrasting hardwoods, 1-inch stock. Appeared on 1971 brochure. About 100 made.

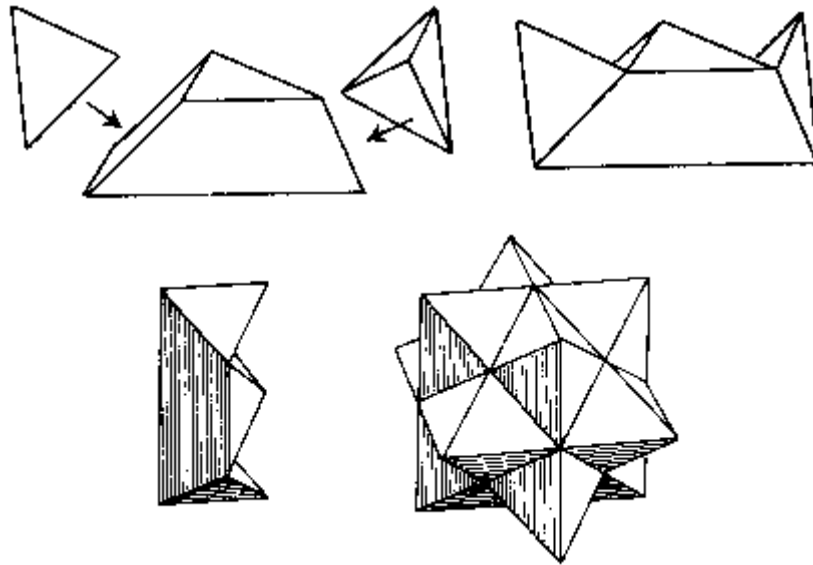

4-A. **Star**. An improved version of the *Sirius* (#4) in 3 fancy woods, 1.25-inch stock. Appeared on 1974 and 1975 brochures. About 400 made.

5. **Spider-Slider**. Six identically shaped symmetrical pieces, each one made of 4 triangular sticks. In basswood stained 4 colors. About 20 made in 1970, my first polyhedral AP-ART in wood. See *PC*'85, p. 51, and *PWPD*, pp. 119-20.

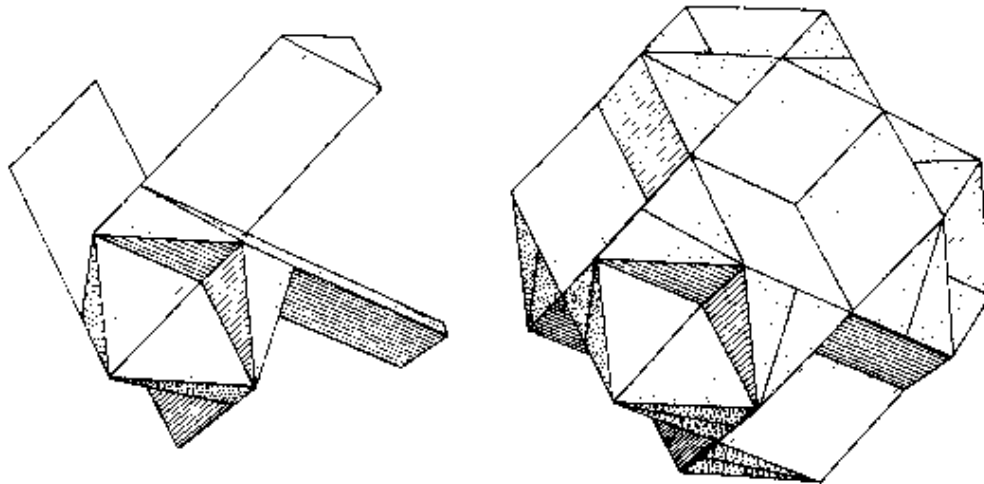

5. **Scorpius**. An improved version of the *Spider-Slider* (#5) in 4 contrasting fancy woods. Appeared on 1971 and 1972 brochures. About 200 made.

6. **Four Corners**. Six identically shaped symmetrical pieces in 4 contrasting fancy woods of 1-inch stock, assemble easily to make a polyhedral solid intermediate between the first and second stellations of the rhombic dodecahedron. Appeared on 1971, 1972, 1974, and 1975 brochures. About 200 made. See *PC*'85, p. 42, *PWPD*, pp. 85-87, and *PC*'92, pp. 38-39. Roy Rice made a version of *Four Corners* in 2 fancy woods for the IPP-14 puzzle exchange.

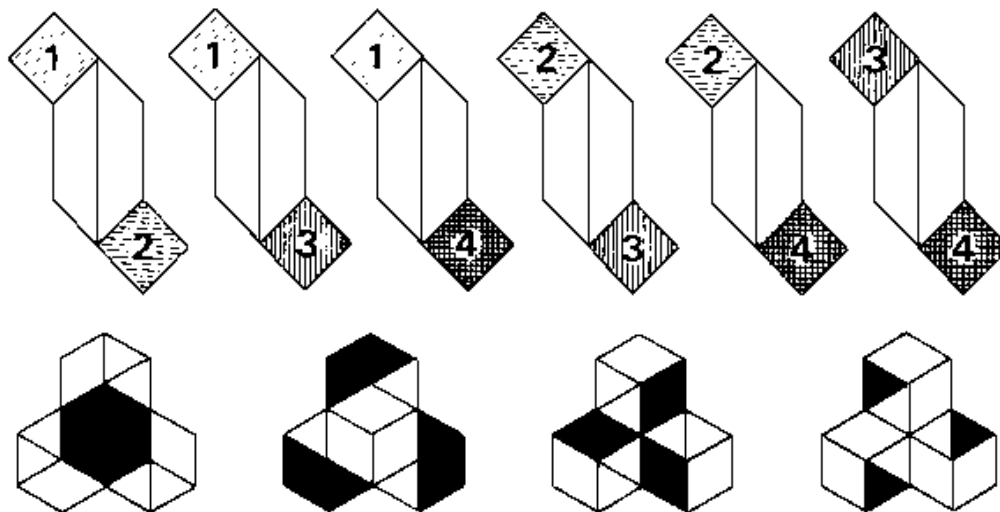

6-A. *Aries*. The plastic version of *Four Corners* (#6) made by Skor-Mor for their Geo-Logic series.

7. *Jupiter*. Twelve identically shaped pieces, each one made up of 5 triangular sticks, assemble to form a hollow nearly spherical solid which I call a castellated triacontahedron. Six contrasting fancy woods are used, to be assembled with color symmetry. Over the years, by far my most popular AP-ART creation, but probably as a sculptural curiosity rather than a mechanical amusement. I'll bet half of those made have never been disassembled! Appeared on 1971, 1972, 1974, 1975, and 1977 brochures. About 400 made. See *PC'85*, p. 52 and *PWPD*, pp. 138-39.

8. *Nova*. Six identical symmetrical pieces easily assemble to form the second stellation of the rhombic dodecahedron. More of a sculpture than a puzzle. Appeared on 1972 brochure. About 100 made of 1-inch zebrawood. See the section titled *The Second Stellation* in *PWPD*, pp. 84-85.

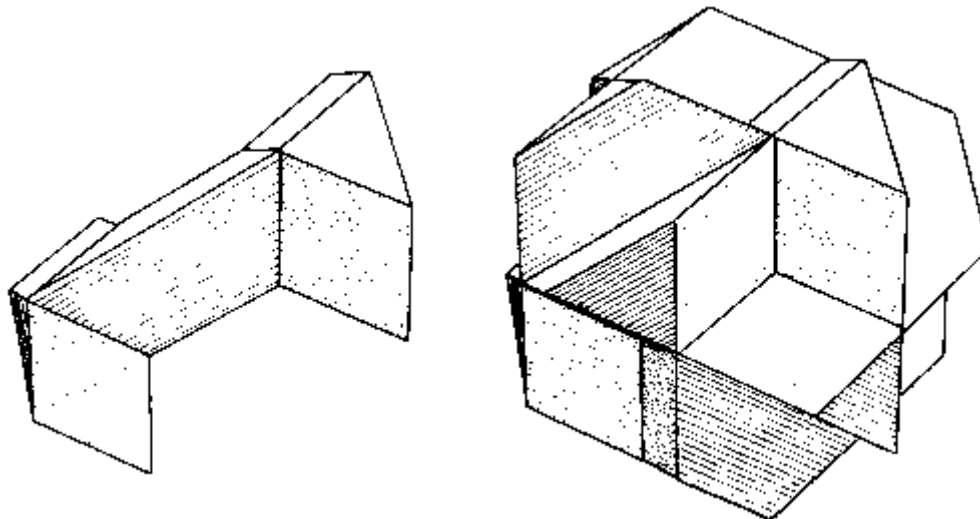

8-A. A plastic version of the above made by Skor-Mor for their Geo-Logic line.

8-B. A fancy version in 4 contrasting woods, color symmetry. Three made in 1987

9. *Square Knot*. (aka *Altekruse*). Twelve identical notched square sticks - a popular design patented by W. Altekruse in 1890 and now in the public domain. My version used 3 contrasting fancy woods of .875-inch stock. I also included 2 extra pieces to make my newly discovered 14-piece version. Appeared on 1974 and 1975 brochures. About 40 made. See *PC'85*. Pp. 36-37 and *PWPD*, pp. 67-69.

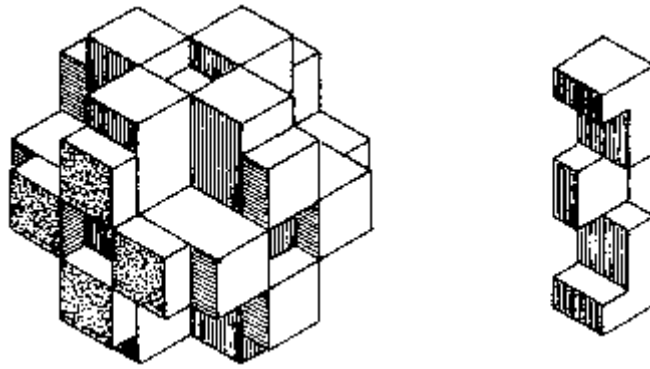

9-A. *Frantix*. A variation on *Square Knot* (#9) with pins and holes in place of notches. Two kinds of pieces, 6 of each. Only 4 made in 1973, as it was a prototype for the plastic version, *Frantix* (#9-B). See *PC*'85, p. 38, *PWPD*, pp. 68-69 and *PC*'92, p. 32.

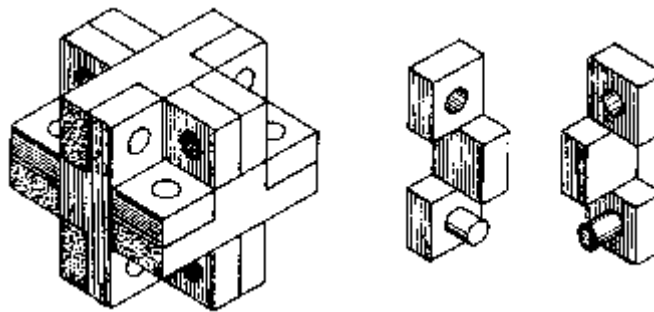

9-B. *Frantix*. This design was licensed to 3M Company in 1974 for manufacture in injection molded styrene as a sequel to *Hectix* (#25). It was very poorly made, with tapered holes, and not a success.

9-C. *Frantix*. This more interesting wooden version had extra pins and holes in the centers, 4 kinds of pieces, 3 of each. Probably about 4 made around 1973. See *PC*'85, p. 38 and *PWPD*, pp. 68-69.

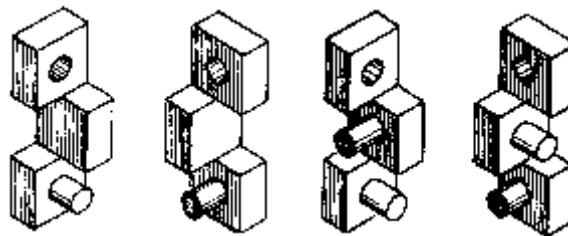

10. *Giant Steps*. A variation of *Square Knot* (#9) (but not an improvement!) made by adding extra blocks to 6 of the pieces to make T-shaped pieces. Appeared on 1974 and 1975 brochures. About 20 made, mostly butternut.

11. *Hexagonal Prism*. Six dissimilar pieces assemble one way only with only one sliding axis - a significant departure from previous AP-ART designs. Appeared on 1974 and 1975 brochures. About 60 made. Also made a set of *Hexagonal Prism*, *Triangular Prism* and *The General* from almond in 1987. See *PC*'85, p. 44 and *PWPD*, p. 99.

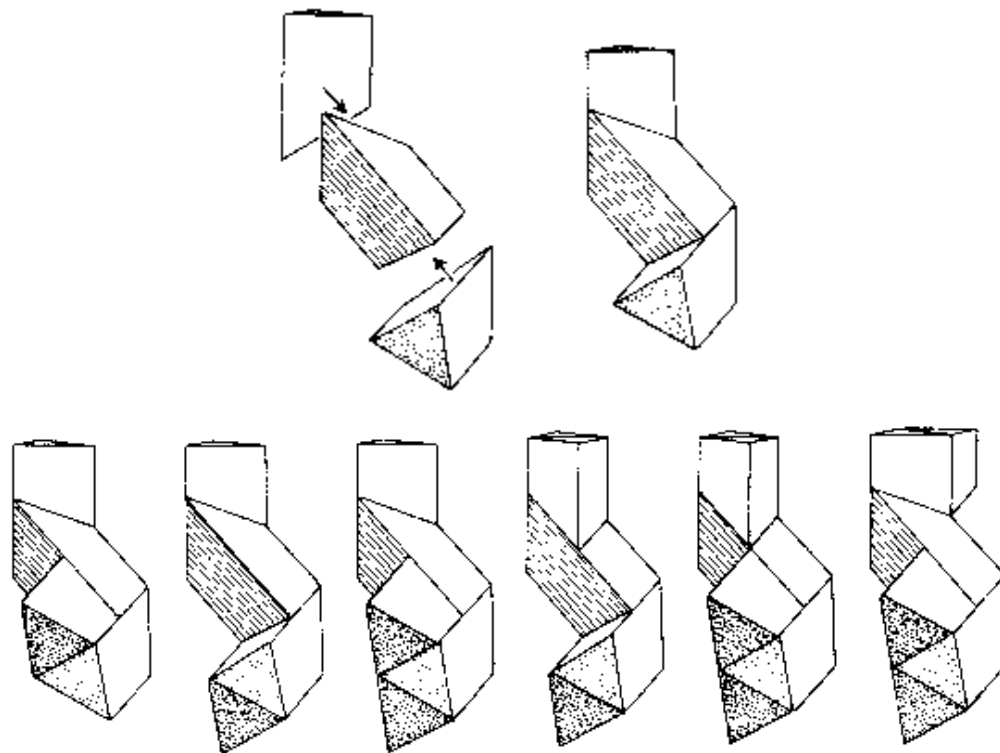

11-A. **Double Hexagonal Prism**. A variation of the **Hexagonal Prism** (#11) with eight faces by adding more blocks. One made. See *PWPD*, p. 100-101.

12. **Triangular Prism**. A variation of the **Hexagonal Prism** (#11) by adding 12 more blocks to transform it into a most intriguing solid - and one that reappears later as **Burr Muda** (#112). Appeared on 1974, 1975, 1980, and 1981 brochures. About 100 made, mostly in mahogany. See *PC'85*, p. 44-45 and *PWPD*, p. 100.

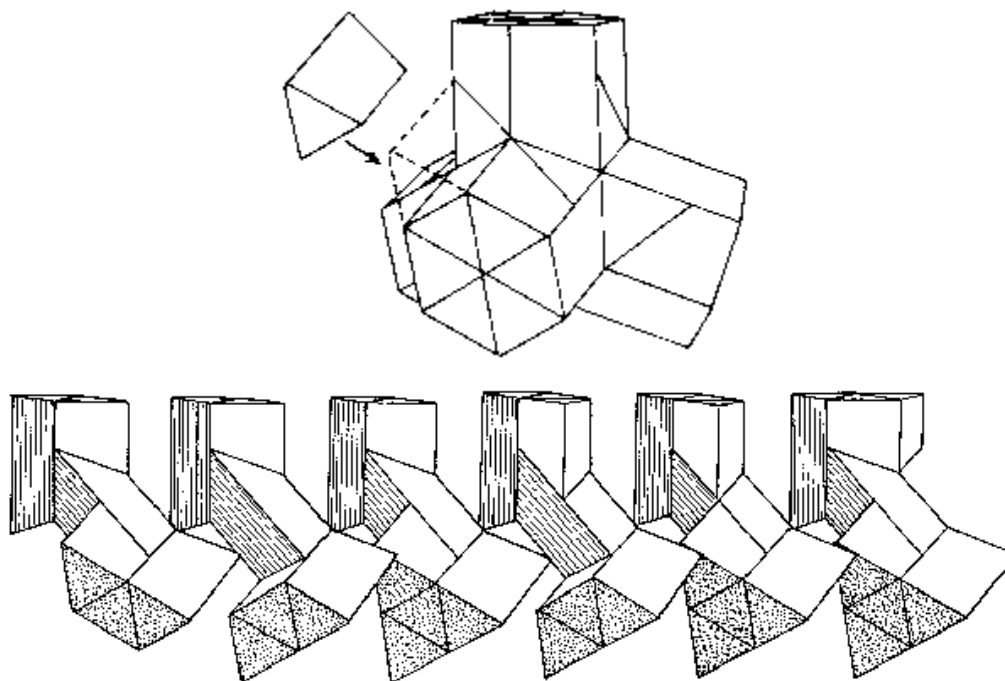

12-A. **Triangular Prism** (elongate version). This was a slightly different version of the **Triangular Prism** (#12). Many such variations are possible depending upon how the additional blocks are placed. Only about 2 made around 1974.

13. *The General (Four Star)*. A variation of *Triangular Prism* (#12) made by adding yet 12 more blocks. Appeared on 1974 and 1975 brochures. About 20 made, mostly in mahogany. See *PC'85*, p. 45 and *PWPD*, p. 100-101.

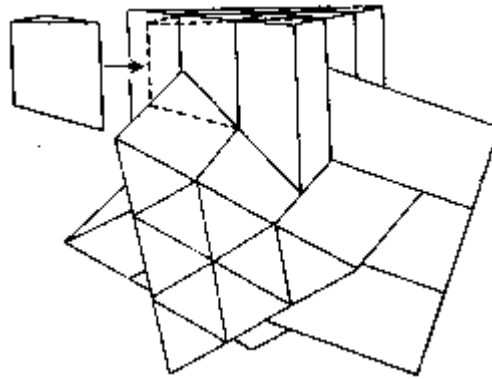

13-A. *The General* (elongate version). Same idea as *Triangular Prism* (#12-A). Only one made, around 1974.

13-B. *Ring of Diamonds*. An interesting variation of *The General* (#13) made using rhombic rather than triangular stick segments. Easier to make. Evidently designed in 1973 and forgotten, then rediscovered in 1995. A few made in 1995. More information on the Dec. 1995 instruction sheet.

14. *Super Nova*. Same shape as *Nova* (#8), but 6 dissimilar pieces, difficult. A few had 8 dissimilar woods, but most were one wood. Appeared on 1974 and 1975 brochures. About 20 made.

14-A. *Second Stellation*. An improved version of the *Super Nova* (#14), more accurately made. Appeared on 1981 brochure. About 50 made in mahogany. See *PC'85*, p. 43 and the section titled *The Permuted Second Stellation* in *PWPD*, p. 90.

A further improved version of *Second Stellation* was made starting in 1983, using triangular rather than square stock. About 50 made in mahogany.

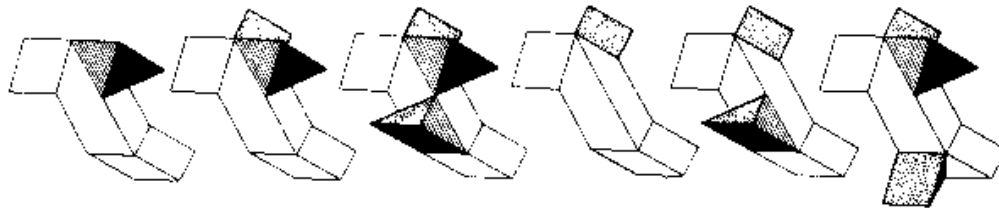

14-B. *Augmented Second Stellation*. A variation of *Second Stellation* (#14) in which the arms are lengthened to make a different shape. Only 2 made in 1990. This was redesigned in 1996 to use smaller .8-inch stock in 4 contrasting fancy woods, and a few more made.

14-X. Experimental Second Stellation

15. *Triumph*. The 6 identically shaped pieces somewhat resemble those of *Four Corners* (#6), but have bilateral rather than axial symmetry. Assembles into 3 different symmetrical polyhedral shapes, the first AP-ART to do so. Use of 2 contrasting woods introduces color symmetry patterns also. Appeared on 1974 and 1975 brochures. About 50 made. See *PC'85*, p. 47, *PWPD*, pp. 105-106, and *PC'92*, pp.47-48.

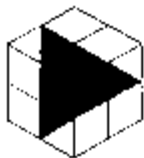
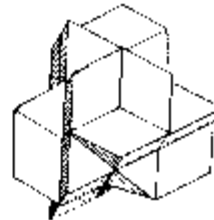
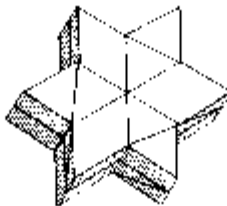
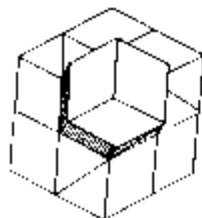
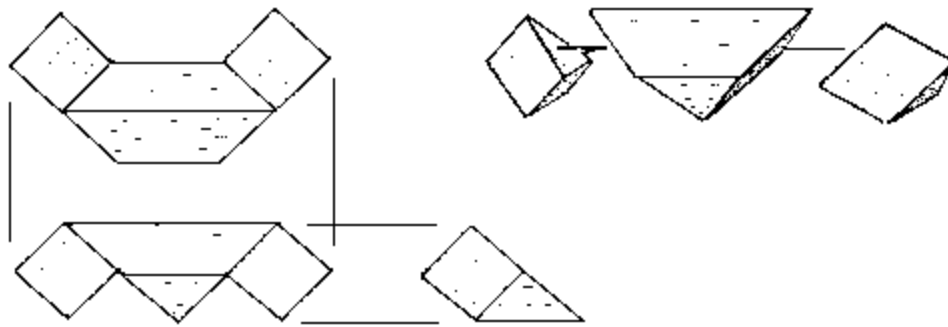

15-2-1 & 15-2-2. *Triumph* and *Triumph Companion*. Consists of a standard *Triumph* and a *Companion* puzzle made with three pieces like the standard but having one end pointing in the opposite direction (like an *S* where the standard pieces are like a *U*) and three pieces with a six-sided center block on one end. The *Companion* has a total of eight symmetrical solutions. By interchanging pieces from the two puzzles, many new interesting shapes are possible.

15-A. *Fusion-Confusion*. By making a *Triumph* (#15) and bonding two pairs of pieces together different ways, an entirely new and more confusing amusement emerges. It likewise makes the 3 different shapes of *Triumph* (#15), but the color scheme is different. First made in 1990, and about 40 made in fancy woods. See *PC'92*.

16. *Dislocated Scorpius*. A variation of *Scorpius* (#5) with 6 identical but non-symmetrical pieces, making it slightly more confusing to assemble and disassemble. Appeared on 1974 and 1975 brochures. About 20 made. See *PC'85* and *PWPD*, Chapter 14.

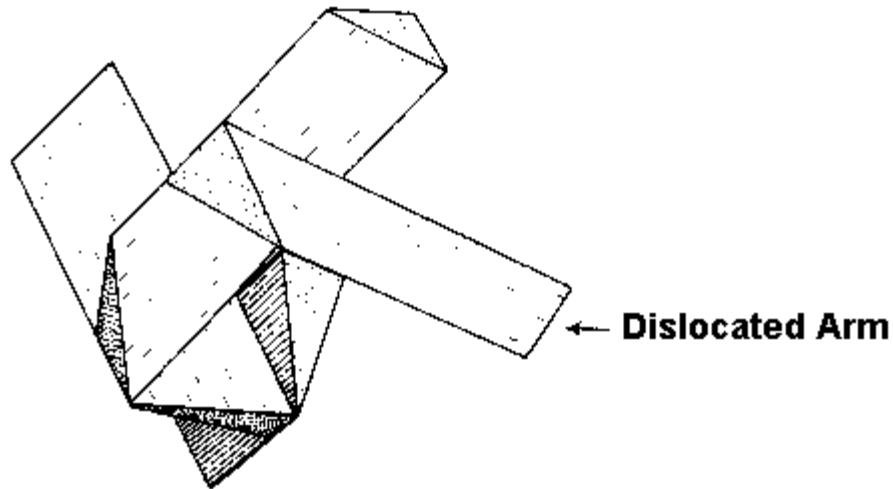

16-X. *Experimental Dislocated Scorpius*.

17. *Dislocated Jupiter*. A variation of *Jupiter* (#7) analogous to *Dislocated Scorpius* (#16). Most and perhaps all were made of one wood. Appeared on 1974 and 1975 brochures. About 10 made. See PC'85 and PWPD, Chapter 17.

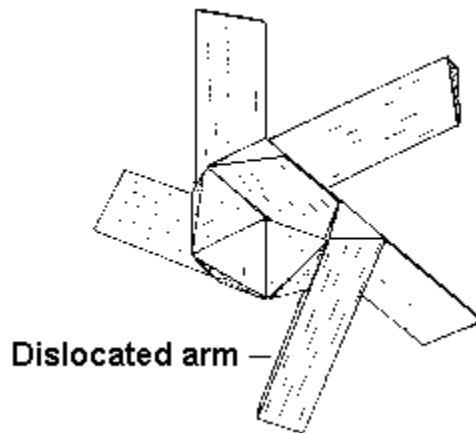

18. *Abbie's Waffle*. Six pieces, each made of 4 cubic blocks, assemble various ways onto a square tray or into a 2x3x4 box. Created by my daughter and demonstrated by her on the PBS children's program ZOOM, first aired 9 Dec 1973. Appeared on 1975 brochure. About 10 made. See PC'85 and PC'92.

18-A. *Joined Pairs*. In the same style as the *Abbie's Waffle* (#18), 6 pieces, each made of 1x1x2 blocks joined different ways, pack into a 2x3x4 box various ways. Only one made in 1990. See PWPD, Chapter 3 and PC'92.

19. *Pyracube*. Four of the pieces are made of truncated rhombic dodecahedron (or edge-beveled cubes) joined different ways, and the 5th piece is a single such block, for a total of 14 blocks. They pack snugly into a their cubic box, with or without the single block, form a square pyramid, a rectangular pyramid, or a triangular pyramid with only 4 pieces. Appeared on 1975 brochure. About 20 made. See PWPD, Chapter 18.

A variation of this design using spheres appears in *Creative Puzzles of the World* by van Delft & Botermans, page 85.

20. *Pin-Hole*. Six 1x1x3 bars with pins and holes assemble easily into a burr-like figure. By adding one or more pieces twice as long, more complicated assemblies are possible. Appeared on 1977 and 1978 brochures. About 50 sets made. See PC'85, PWPD, Chapter 6, and PC'92.

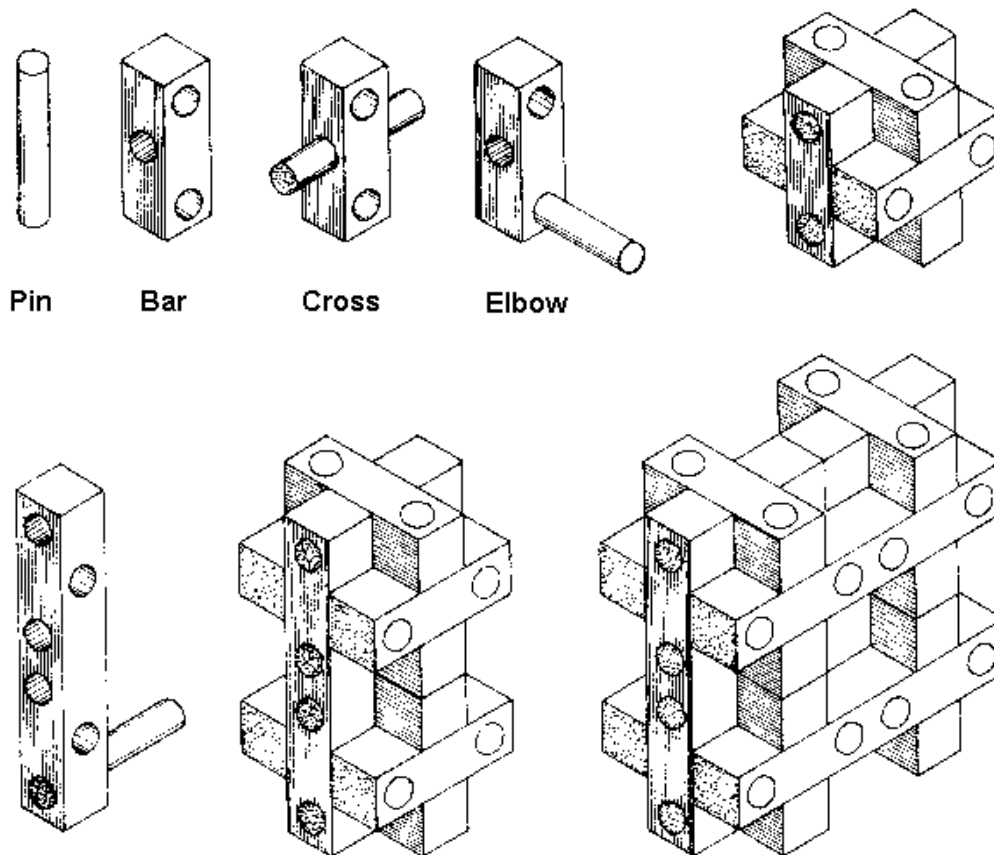

20-A. **King Pin**. This was a variation of **Pin-Hole** (#20) but with blind holes and free pins as a sort of puzzling large construction set. It never got beyond the development stage in 1975.

20-B. **Goose**. A variation of **King Pin** (#20-A) but with animated figures, likewise never went beyond the development stage in 1986

21. **Cuckoo Nest**. Six hexagonal bars are held together with 6 dowels. Two solutions. Appeared on 1977, 1978, and 1979 brochures. About 100 made in birch. See *PC'85* and *PWPD*, Chapter 13.

22. **Locked Nest**. Twelve hexagonal bars are held together with 12 dowels in a symmetrical assembly. There are 2 versions. Most of those made had 5 elbow pieces, but the more challenging version has 6 elbows. Appeared on 1977, 1978, and 1979 brochures. About 100 made in birch. See *PC'85* and *PWPD*, Chapter 13.

22-A. **Locked Nest** (three-hole variation). This is simply a version of the **Locked Nest** (#22) in which the bars and dowels are shortened so that the end holes are eliminated. Only one made in 1990. Never illustrated, but use your imagination.

22-B. **Siamese Locked Nests**. Two **Locked Nests** (#22) joined together using longer bars. See *PWPD*, Chapter 13. Two made in 1989. (Many other variations are possible.)

23. **Scrambled Scorpious**. A variation of **Scorpious** (#6) in which all the pieces are dissimilar and non-symmetrical. Only one solution and one order of assembly. Much more difficult than I realized when I first offered it. One of my most satisfactory AP-ART designs. Appeared on 1978, 1979, 1980, and 1981 brochures. About 200 made. See *PC'85* and *PWPD*, Chapter 14.

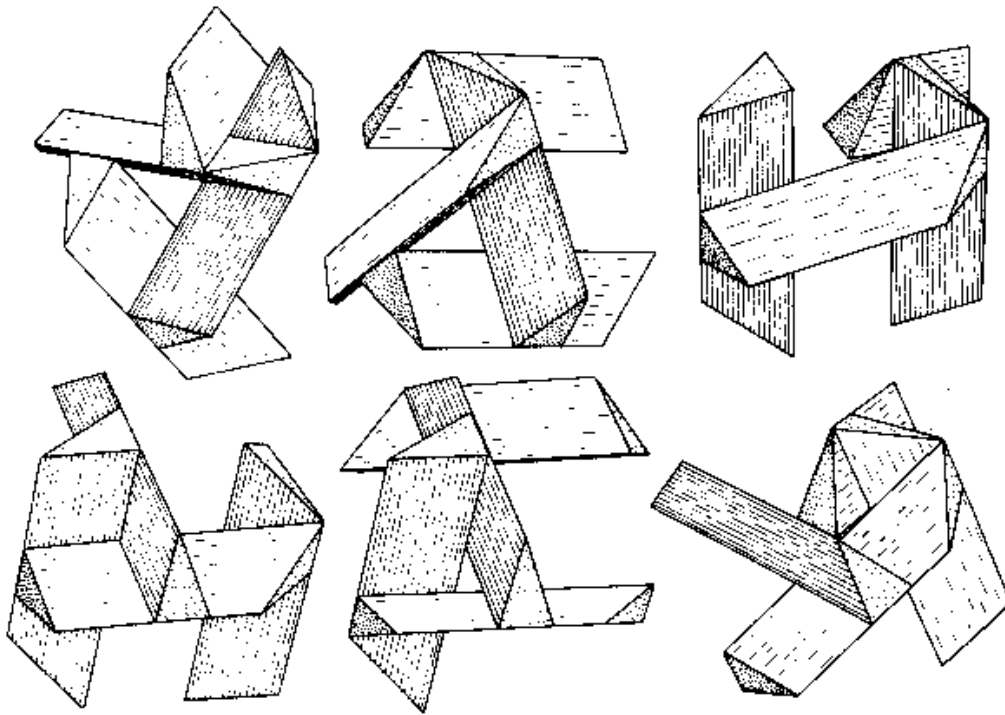

23-A. *Egyptian*. An improved and enlarged version of *Scrambled Scorpius* (#23), with the solution coded on the pieces. A few made in oak, 1993-1995.

24. *Saturn*. Similar to *Jupiter* (#7) except 6 kinds of pieces, two of each. Intended to have only one solution, but other solutions have been discovered. Appeared on 1978, 1979, 1980, and 1981 brochures. About 65 made, mostly in one kind of fancy wood. The deluxe versions had 6 kinds of wood and doweled joints. See *PC'85* and *PWPD*, Chapter 17 for description.

25. *Hectix*. Twelve notched hexagonal bars interlock to form a symmetrical assembly. Nine bars have 2 notches and 3 bars have 3 notches. There are 3 distinctly different solutions. Patent 3721448. One of my most satisfactory AP-ART designs, discovered independently by Bill Cutler around 1965. This is the plastic version licensed to 3M Company in 1970. About 100,000 made. It was supposed to be in 4 colors, but they never got it. See *PC'85* and *PWPD*, Chapter 13. Copies have been made in Japan, France, and Australia.

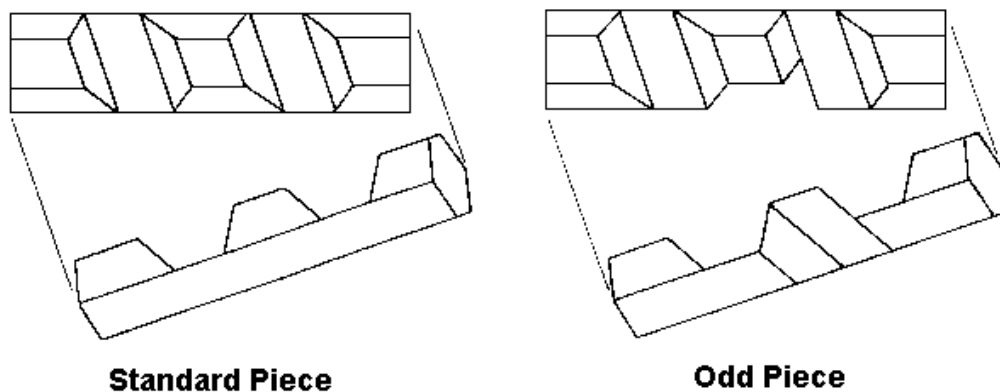

25-A. *Hexsticks*. This is my wooden version of the *Hectix* (#25) in which 7 bars have 2 notches, 3 bars have 3 notches, and 2 bars have one notch. Same solutions possible. Appeared on 1979 and 1981 brochures. About 150 made, mostly birch.

25-B. *Giant Hectix*. Wooden version of the original *Hectix* (#25) but twice the size - 1.5-inch hexagonal stock. A few made in 1993.

25-C. **Four-Color Hexsticks**. A wooden version of the original **Hectix** (#25), but in 4 contrasting colors as it was supposed to have been, and larger - 1-inch instead of .75-inch. A few made in 1995.

25-D. **Hextix**. A wooden version made by Bits & Pieces and seen by me only in their 1996 catalog.

26. **Four-Piece Pyramid**. Four pieces, each made of 4 rhombic dodecahedron blocks joined different ways, assemble with surprising confusion one way and one order only to build a pyramid. Appeared on 1979 and 1981 brochures. The first 12, made in 1976, used edge-beveled rosewood cubes and doweled joints. The next 30, made around 1979, used 1-inch cherry rhombic dodecahedron blocks. About 25 were made starting in 1981 with larger edge-beveled cubes. In 1997, I made a few in contrasting fancy woods. See *PC'85* and *PWPD*, Chapter 18.

27. **Three Pairs**. Two kinds of pieces, 3 of each, assemble with amazing difficulty, to make the solid shown. My first truly coordinate motion puzzle, and still one of the best. Appeared on 1979 and 1981 brochures. About 150 made in mahogany. In 1986, a deluxe edition of 10 were made in rosewood with doweled joints. See *PC'85*, *PWPD*, Chapter 10, and *PC'92*.

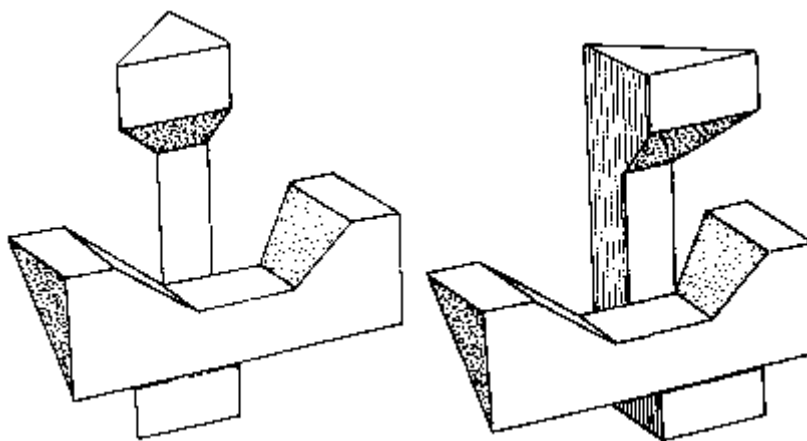

27-A. **Three Pairs Variation**. (aka **Split Second**) Several variations are possible, all with the same internal function but different external shape. The one with this designation is the second stellation of the rhombic dodecahedron, only one model made. I have also made a model having the shape of the first stellation of the rhombic dodecahedron, and another resembling the **Four Corners** (#6). Used as an exchange puzzle at IPP-19.

28. **Truncated Octahedra**. Five pieces made of 14 truncated octahedra blocks pack into a square box. Twelve-page booklet shows 18 other problems. Appeared on 1979 and 1981 brochures. About 50 made using 1.5-inch mahogany cubes with corners removed and box of Baltic birch which could be inverted to hold the square pyramid construction. See *PC'85* and *PWPD*, Chapter 18.

29. **Half-Hour**. Six-piece 3x3x3 cubic dissection with unique solution. H. Havermann and D. Barge submitted dozens of other construction problems. Appeared on 1980 and 1981 brochures. About 50 made of 1-inch stock. Reissued in 1984 using 6 contrasting woods and a box of blue mahoe. See *PC'85*, *PWPD*, Chapter 3, and *PC'92*.

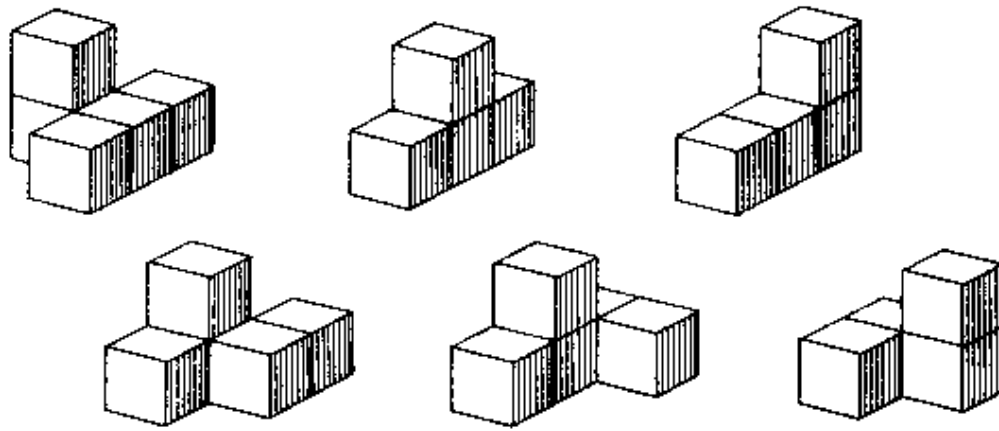

30. **Convolution**. Seven pieces assemble one way only and in one order only to form a 4x4x4 interlocking cube with symmetrical pattern on all 6 faces. Appeared on 1980 and 1981 brochures. About 50 made of .75-inch stock. See *PC'85*, *PWPD*, Chapter 4, and *PC'92*. Recently a fine reproduction of this design has been made by Wayne Daniel.

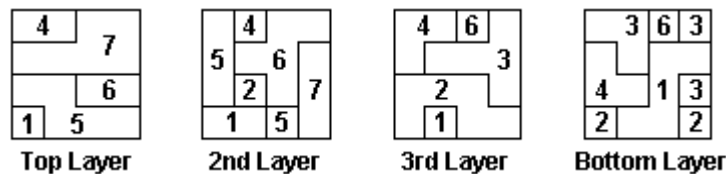

31. **Octahedral Cluster**. Four pieces made of 19 rhombic dodecahedron blocks assemble one way only and in one order only to form an interlocking octahedral cluster. Baffling. Appeared on 1980 and 1981 brochures. About 40 made of 1.25-inch limba rhombic dodecahedron blocks. See *PC'85*, *PWPD*, Chapter 18, and *PC'92*.

31-A. **Five-Piece Octahedral Cluster**. Like the **Octahedral Cluster** (#31) except 5 pieces. Perhaps even more baffling. Recently I have made a few from 1-inch edge-beveled cubes of 5 fancy woods.

32. **Broken Sticks**. Six dissimilar pieces made of triangular stick segments assemble one way only with one sliding axis. Difficult. Appeared on 1980 and 1981 brochures. About 50 made. See *PC'85* and *PWPD*, Chapter 9.

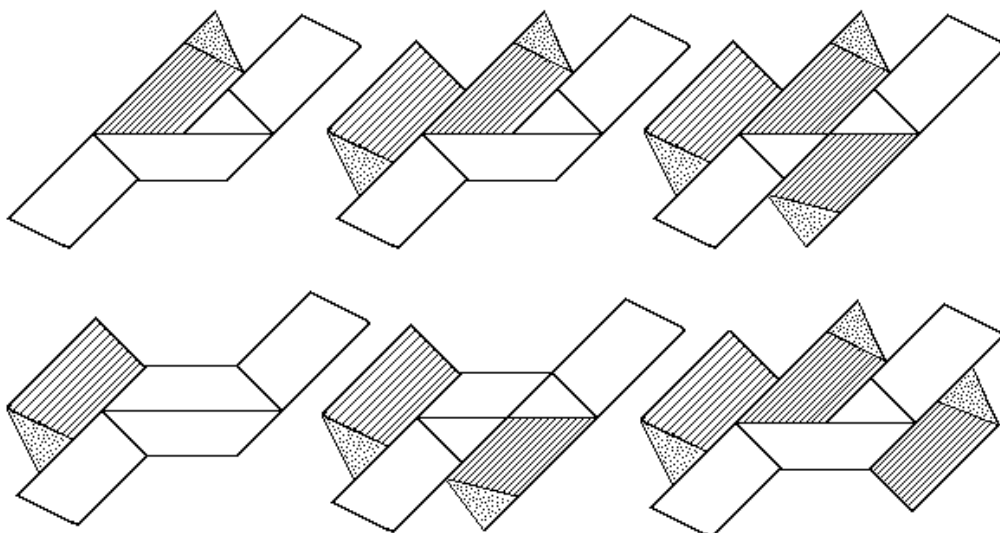

33. **Twelve-Point**. Six dissimilar pieces assemble one way only to form an intriguing solid intermediate between 2nd and 3rd stellations of the rhombic dodecahedron. Appeared on 1981 brochure. About 50 made of 1-inch stock in 2 contrasting woods. See *PC'85* and *PWPD*, Chapter 9.

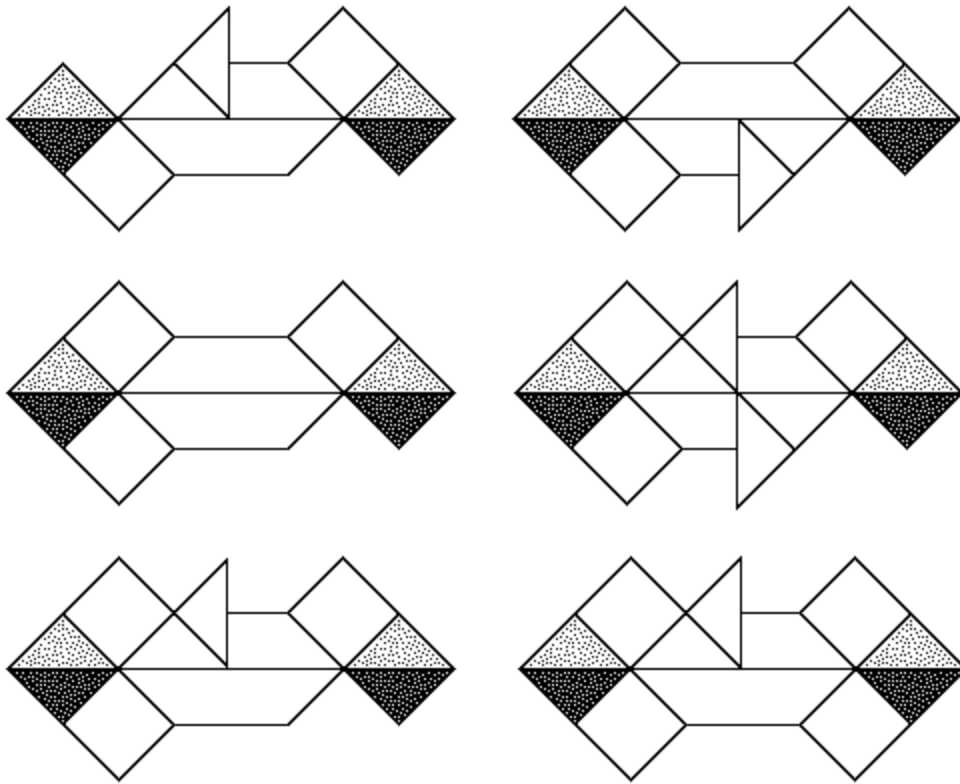

33-A. *Twelve-Point*. A remake of the *Twelve-Point* (#33) in .8-inch stock. A couple made in 1996.

34. *Augmented Four Corners*. Six pieces assemble one way only with one sliding axis. Appeared on 1981 brochure. About 60 made of 1-inch stock in 2 contrasting woods. See *PC'85* and *PWPD*, Chapter 9.

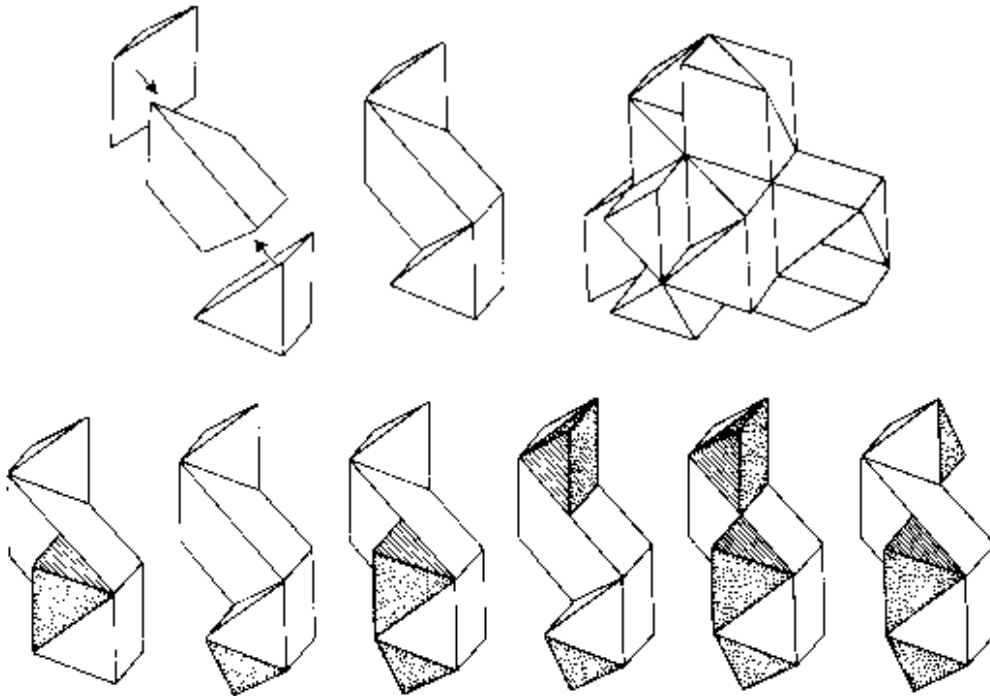

34-A. *Modified Augmented Four Corners*. These are variations of the *Augmented Four Corners* (#34) made by sanding the four faces down by varying amounts to create interesting sculptural effects, especially when using contrasting woods. Two versions made, one model of each, probably in early 1970's. One is shown.

35. **Burr #305**. Ordinary notchable **Six-Piece Burr** with unusual 3+3 solution. Appeared on 1981 brochure. About 60 made of 1-inch stock. See *PC'85*, *PWPD*, Chapter 5, and *PC'92*.

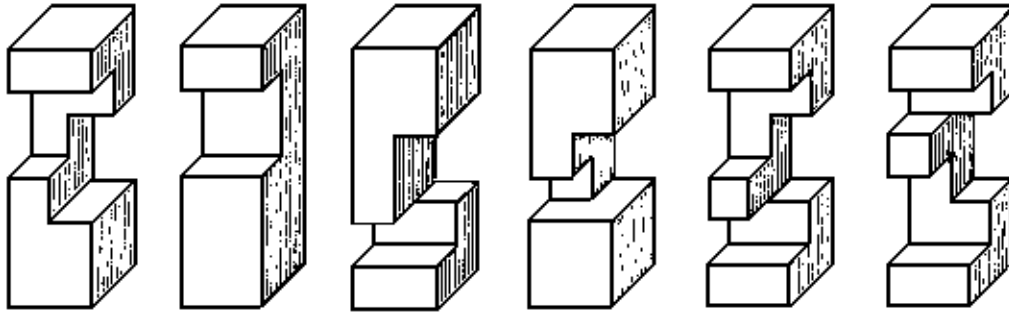

36. **Coffin's Improved Burr**. More complicated than **Burr #305** (#35), with 5 shifts to release the first two pieces. Appeared on 1981 brochure. About 50 made. See *PC'85*.

37. **Star-of-David**. Six dissimilar non-symmetrical pieces assemble to form three different interlocking polyhedral solids with confusing diagonal axes of assembly. Appeared on 1981 brochure. About 50 made of 1-inch mahogany stock. See *PWPD*, Chapter 11.

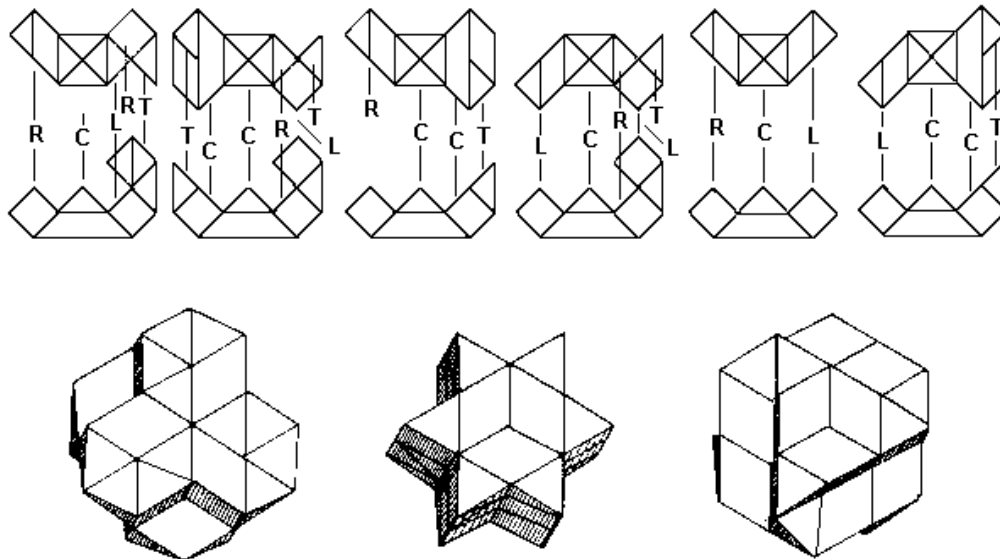

37-A. **Star-of-David**, improved version. Same as **Star-of-David** (#37) but achieved with simpler pieces. About 12 made, beginning in 1990. In 1997, a few made of .8-inch stock in 2 contrasting fancy woods. See *PC'92*.

38. **Three-Piece Block**. Three pieces made of 10 cubic blocks interlock to form a triangular pyramid. Surprisingly confusing. First 300 made of cherry for Citibank in 1980. About 50 more made starting in 1981, all of 1-inch blocks. See *PC'85*, *PWPD*, Chapter 4, and *PC'92*.

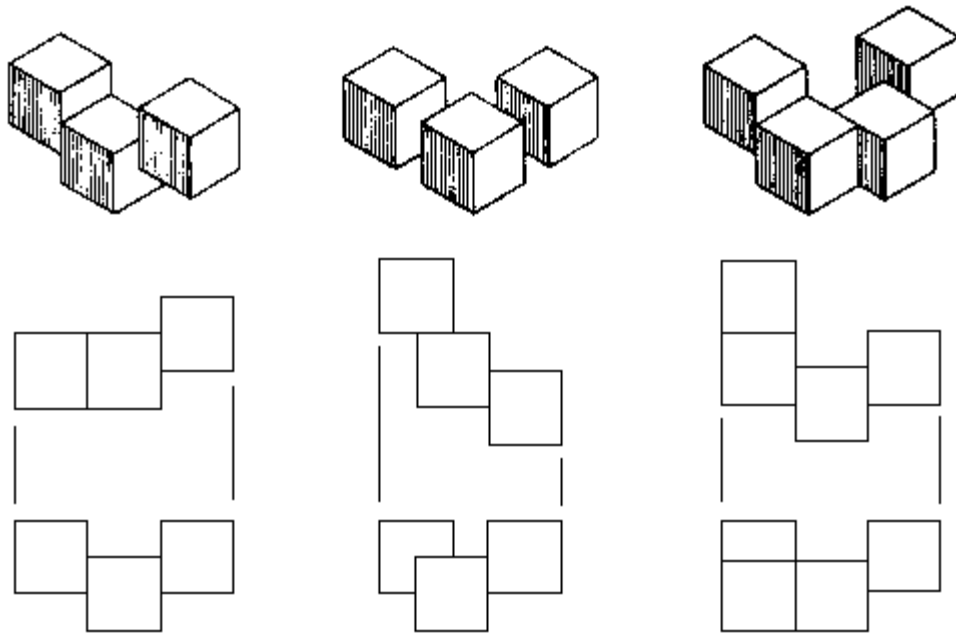

39. **Rosebud**. Two kinds of pieces, 3 of each, assemble with much difficulty by coordinate motion to form an intriguing polyhedral solid. About 42 made, starting in 1982. Some were in mulberry and cherry, others the deluxe in rosewood and tulipwood. See *PWPD*, Chapter 12.

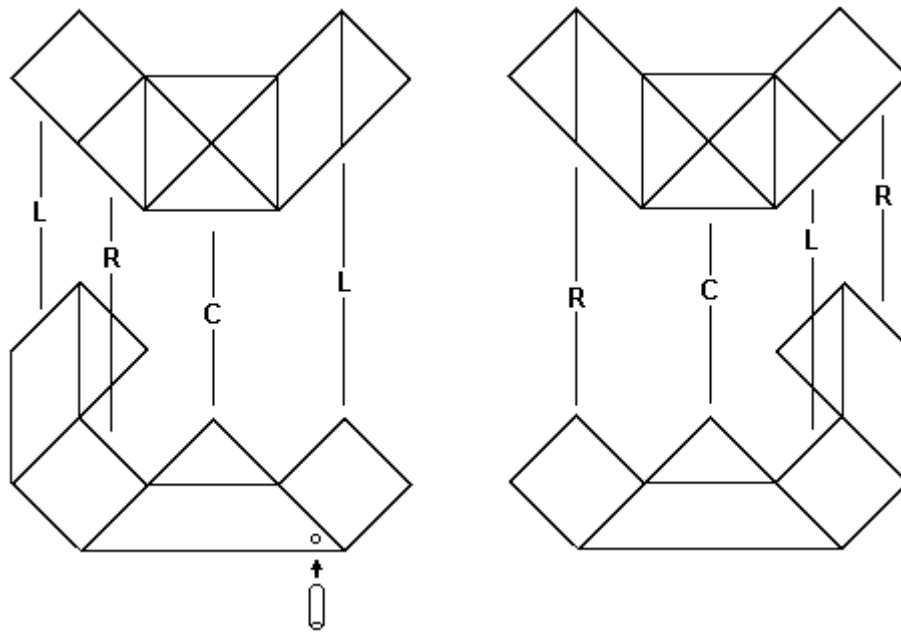

39-A. **Rosebud Assembly Jig**. Was made available later. Could (perhaps) be assembled without, but much easier with. About 32 made, starting in 1983.

40. **Interrupted Slide**. A higher-level **Six-Piece Burr** with one or two interesting solutions, depending upon the length of pieces. Made 28 in 1982 of golden bilinga. See *PC*'85.

41. **Unhappy Childhood**. Ten checkered pieces, each made of 5 cubic blocks joined different ways, pack into a 5x5x2 box. About 50 made, 1983-1984. See *PWPD*, Chapter 3, page 47.

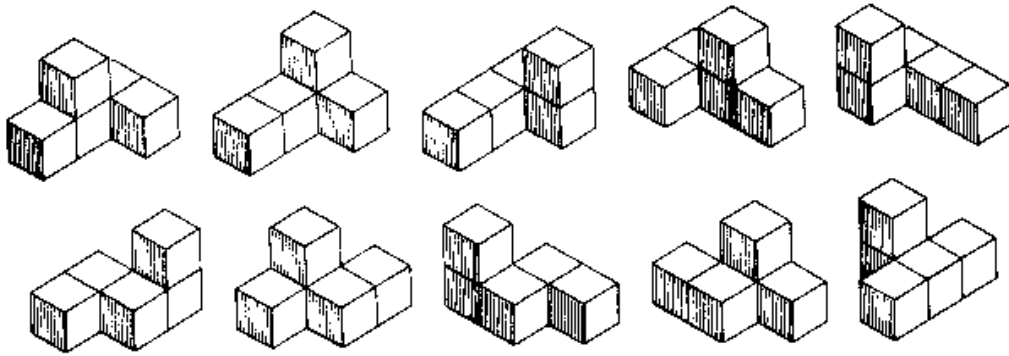

42. *Seven Woods*. Six simple pieces make a modified *Diagonal Burr*. About 20 made in 1971. See *PC'85*

42-A. *Brickyard*. A *Seven Woods* distorted by flattening along vertical axis. Only 2 made. Proposed for 1996 exchange puzzle but never used. Too simple perhaps.

43. *Sleeper-Stopper*. (Topological - not AP-ART)

44. *Super Sleeper-Stopper*. (Topological - not AP-ART)

45. *Buttonhole*. (Topological - not AP-ART)

46. *Vega*. Six simple identical pieces assemble easily to form an attractive solid. About 30 in fancy woods, 1-inch stock, sold at craft shows, 1972-1975.

46-A. *Vega II*. Same shape as *Vega* (#46), but made by truncating *Superstar* (#50). Maybe made one or two.

47. *Cluster-Buster*. Six identical pieces assemble easily into a polyhedral solid, but trickier to disassemble. About 5 made in 1973. See *PC'85* and *PWPD*, Chapter 9, page 97.

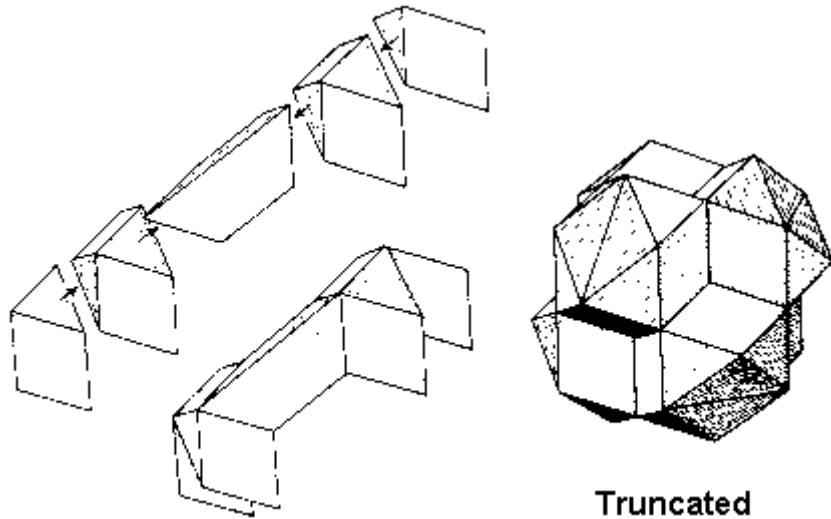

47-X. *Experimental Cluster-Buster*

48. *Truncated Cluster-Buster*. Minor variation of the *Cluster-Buster* (#47). About 5 made in 1973.

49. *Improved Cluster-Buster*. Variation of the *Cluster-Buster* (#47) with dissimilar pairs of pieces. An unpublished design. About 10 made in 1973.

50. *Superstar*. Six identical pieces assemble easily to make 3rd stellation of rhombic dodecahedron. About 10 made in mahogany for craft shows, 1972-1975. See *PWPD*, Chapter 8, page 83.

50-A. *Superstar II*. Variation of the *Superstar* (#50). One made in 1990. See *PWPD*, Chapter 8.

50-B. *Third Stellation*. Version of *Superstar II* (#50-A) in 4 contrasting fancy woods, to be assembled with color symmetry. Proposed in 1986 but never made. See *PWPD*, Chapter 8.

51. *Little Superstar*. Truncated version of *Superstar* (#50). Six identical pieces make 2nd stellation of the rhombic dodecahedron. Just a sculpture. Probably made a few.

52. *Pennyhedron*. Two pieces form rhombic dodecahedron. Amusing to take apart. Invented by my kids in 1971 while playing with scraps. With variations too numerous to mention. Made about 150, 1971-1985. See *PC'85*, *PWPD*, Chapter 15, and *PC'92*.

52-A. *Hole-in-One*. Simple 3-piece derivative of *Pennyhedron* (#52) with pin and hole, coordinate motion. Proposed exchange puzzle but never used. Unpublished design.

52-B. *Button Box*. A distorted *Pennyhedron* (#52) in 4 fancy woods, used as an exchange puzzle at IPP-16.

52-C. *Pennyhedron Trick Pair*. A pair of Pennyhedrons which look alike but come apart two different ways. Only one set made. See *PC'85* and *PWPD*, Chapter 15.

53. *Little Giant Steps*. An uninteresting variation of *Giant Steps* (#10) in which the added blocks are cubic instead of 1x1x2. About 3 made in 1973.

54. *Defiant Giant*. A bizarre variation of *Giant Steps* (#10) in which the added blocks are attached differently. The first piece is a standard *Square Knot* (#9) piece of length 5, of which six are required. The next piece has a 1 x 1 x 1.5 block attached, and the next two a 1 x 1 x 2 block, one of each required. The last piece also has a 1 x 1 x 2 block, three required. Very tricky to assemble. Not previously published. Only one made in 1973.

55. *Pagoda*. Eight cubic blocks are added to the *Square Knot* (#9), resulting in 3 kinds of pieces, 4 of each. Somewhat trickier than standard *Square Knot* (#9) to assemble. Probably a few made in 1973.

56. *Giant Pagoda*. This version combines both the added blocks of *Giant Steps* (#10) and *Pagoda* (#55), resulting in 6 kinds of pieces, 2 of each. Probably made a few in 1973.

One of the delights of this editorial project is rediscovering old models, or plans for same, that were filed away many years ago and forgotten. Usually the reasons for putting them aside are obvious. On the other hand, in the light of experience sometimes new ways are seen to correct some deficiency. Every design listed here has its roots in previous designs, sometimes recombining in unexpected ways. Alas, such is not the case with the four dull ideas listed above, at least not yet.

57. *Plus 2*. The 14-piece version of *Square Knot* (#9). See *PC'85* for the amusing story of this design and its many variations. I may have made about 20 of these, 1973-1975, but my records did not always distinguish between the 12- and 14-piece versions. I made a few of the larger versions also, such as the 24- and 36-piece.

58. *Diagonal Cube*. Six pieces in 2 contrasting woods assemble diagonally to form an attractive cube. About 20 made in fancy woods, 1981-1985. See *PC'85* and *PWPD*, Chapter 9.

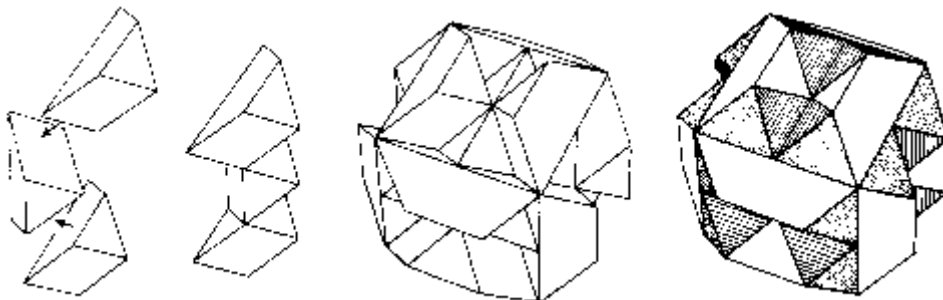

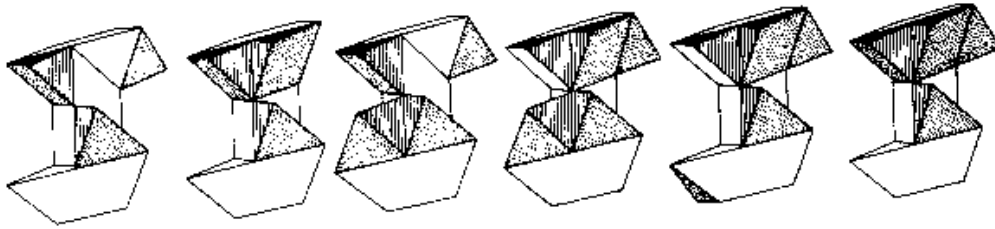

59. **Corner Block.** A *Pin-Hole* (#20) with 8 cubic blocks added to the corners. About 30 made in, starting in 1980. See *PC*'85.

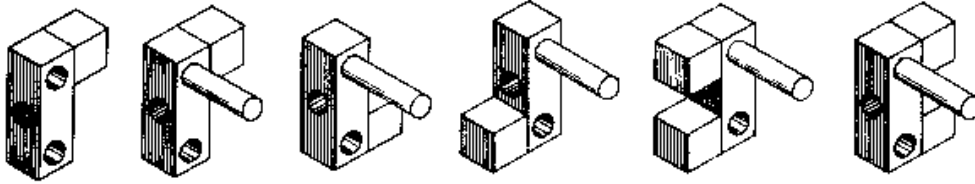

59-A. **Improved Corner Block.** Designed in 1985 to replace *Corner Block* (#59). About 15 made. See *PC*'92.

A nice replica of *Corner Block* (#59) has been made by Wayne Daniel.

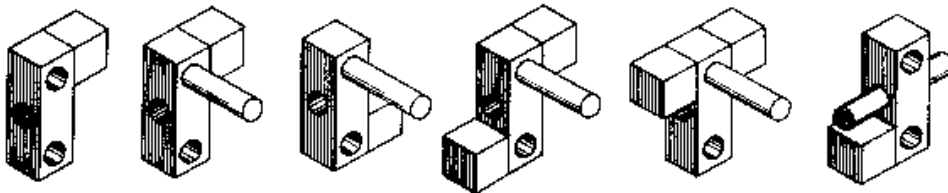

60. **Garnet.** Six dissimilar pieces, each made of 4 tapered blocks, assemble into a rhombic dodecahedron. Appeared on 1984 brochure. About 30 made. See *PWPD*, Chapter 15.

61. **Setting Hen.** Four pieces made of 14 rhombic dodecahedron blocks fit into a cubic box and construct other problem shapes. Appeared on 1984 brochure. About 30 made. Design not published.

61-A. **Distorted Cube.** A revised and improved version of the *Setting Hen* (#61), made instead with edge-beveled cubic blocks. Tricky box makes both cubic and rectangular insides. Designed in 1988. About 20 made. See *PC*'92.

62. **Nine Bars.** Same idea as *Cuckoo Nest* (#21), but 9 bars and dowels instead of 6, and 3 layers instead of 2. Only one solution known - difficult. Appeared on 1984 brochure. About 10 made in birch. See *PWPD*, Chapter 13.

63. **Pseudo-Notched Sticks.** Six identical pieces. A novelty. Looks like ordinary *Diagonal Burr* but comes apart differently. About 25 made in 1985. See *PC*'85 and *PWPD*, Chapter 16.

64. **Expanding Box.** Just a novelty. Six identical pieces enclosing cubic space expand with coordinate motion. Two made in 1971. See *PWPD*, Chapter 12.

65. **Thirty Notched Sticks.** In my file of design ideas for 1972, I list theoretically a rhombic version and a couple of pentagonal versions. Shown are a cast epoxy triangular version and a rough wood pentagonal version. For more information, see *PWPD*, Chapter 17.

65-A. **Thirty Notched Rhombic Sticks.** This version of the *Thirty Notched Sticks* (#65) has an instruction sheet dated 1987, evidently the year that a few were made. See *PWPD*, Chapter 17.

66. **Crystal Blocks.** The pieces are rhombic dodecahedron blocks joined together different ways. Originally cast in epoxy, this would be listed in Part 1 except that I tinkered with wooden versions also. There were various sets tried, but the final version had 6 pieces and 22 blocks. It never got beyond

design stage, but still it was an entertaining project, I proposing the sets of pieces and their associated problems, and Mike Beeler analyzing them using his computer. Only a few sets were actually made, either cast epoxy or wooden. But who cares if it never went into production. We had fun doing it! I still have all the papers, in case anyone wants to pursue something along these lines.

67. **Peanut**. Six polyhedral pieces fit together many ways to construct problem shapes. Designed in 1973 for possible manufacture in plastic. Resurrected in 1986 to make in wood. Made about 30 in 1-inch mahogany. See *PC'85*, and *PC'92*.

67-A. **Shatterblock**. Same idea as **Peanut** (#67), but based on a different dissection of the rhombic dodecahedron - three-pronged as in **Pennyhedron** (#52). Five kinds of pieces, two of each. Designed in 1973, and originally intended for production in plastic, which influenced the choice of design for ease of injection molding. Never got beyond design stage. Unpublished.

67-B. **Pennydoodle**. Improved version of **Shatterblock** (#67-A). Five pieces fit together many different ways. Eight problem shapes shown. About 30 made, 1989-1990. To be entirely satisfactory, they had to fit together precisely. But they had a tendency to warp and then not fit, so discontinued making. See *PC'92*.

68. **Confessional**. Variation of **Square Knot** (#9) using 85 degree rhombic sticks rather than square, .75 x 3 inches. Two kinds of pieces, 8 of one and 4 of the other. Tricky solution involves rotation. Designed in 1994.

68-A. **Leaning Tower of Altekruse**. A 14-piece variation of **Confessional** (#68-B). An IPP-15 exchange puzzle.

68-B. **Confessional** (long version). Like the original **Confessional** (#68) except sticks are 5 units long instead of 4. Even more confusing. One of my most satisfactory designs, but only a few made because of the labor of sawing out the slant notches with multiple saw cuts. With a special cutter, would be easy.

69. **Unnamed**. Distorted variations of **Scorpius** (#5) and **Jupiter** (#7) that never got beyond preliminary design stage.

70. **Improved Saturn**. An improved version of **Saturn** (#24) with unique solution. Never found one. See *PWPD*, Chapter 17. Also see **Sphinx** (#164)

71. **Stucksticks**. A **Hexsticks** (#25-C) in 4 colors, but with 4 pairs of pieces bonded together for greater difficulty. Designed in 1995, and so far only 3 made. Unpublished.

71-A. **Stucksticks** (harder version). Variation of **Stucksticks** (#71), with only one kind of wood, even more confusing. Proposed but not yet made.

72. **Design Number 72**. Based on a dissection of the triacontahedron into 60 identical wedge-shaped blocks. In this version, each piece made of 6 blocks, all pieces dissimilar and non-symmetrical, and each a different kind of wood. Six made in 1985. Unpublished design, but this illustration gives a hint.

72-A. **Design Number 72** (two-tiered version). Very complicated. Evidently one made in 1990, unpublished and unrecorded. In the two-tiered version, the blocks of the outer shell are truncated to make space for the inner layer. The inner layer are truncated also, because easier to make that way.

73. **Seven-Piece Third Stellation**. Tricky! All 7 pieces dissimilar and non-symmetrical. First step is 3-piece coordinate motion, remaining steps serially interlocking. Evidently designed in early 1970's and forgotten. Rediscovered in 1985, and five made in 1-inch mahogany. A satisfactory but unpublished design.

73-A. **Seven-Piece Third Stellation** (modified). This version of the **Seven-Piece Third Stellation** (#73) was designed in 1996 to incorporate a very tricky rotation in the coordinate motion first step of assembly. Unfortunately, this results in 2 pieces being identical and the final piece being a plain straight

stick. A few made in .8-inch fancy woods, four colors. Unpublished design. I think I prefer the original version.

74. **Square Face**. To the *Pseudo-Notched Sticks* (#63), 12 additional notched blocks are attached, making 6 dissimilar non-symmetrical pieces. Two solutions. About 20 made, 1987-1988. See *PWPD*, Chapter 16.

74-A. **Square Face** (improved). A variation of *Square Face* (#74), likewise 6 dissimilar non-symmetrical pieces, one solution with minor variations, coordinate motion.

75. **Split Star**. Complicated two-tiered variation of *Garnet* (#60), with the added outer layer making the first stellation of the rhombic dodecahedron. Four made in 1985 of applewood. See *PC*'85.

75-A. **Two Tiers**. Could be considered two *Garnet* (#60) types, one inside the outer hollow one. Designed and illustrated in 1988, but never made. See *PWPD*, Chapter 15.

75-X. **Experimental Two Tiers**

76. **Cornucopia**. A large family of designs involving fitting 10 hexominos chosen from a special set of 17 onto an 8 x 8 tray. Analyzed by M. Beeler around 1985 using a powerful computer and sophisticated techniques. About 100, all different, made 1985-1987. Also made in kit form. See *PWPD*, Chapter 2.

76-A. **Cornucopia 105747** (the *Copious Cornucopia*). Selected from among the 8203 possible usable sets for greatest versatility of solutions. About 30 made, 1985-1986, using 10 contrasting fancy woods.

76-B. **Cornucopia 107715**. Used in the IPP-16 puzzle exchange.

77. **Pieces-of-Eight**. Eight dissimilar pieces join together different ways to construct a cube and 8 other shapes. About 25 made, 1986-1988. See *PWPD*, Chapter 21.

78. **Pillars of Hercules**. Has superficial appearance of an ordinary 5-piece dissection of a 3x3x3 cube, but two of the pieces break in two, using a joint as in *Pieces-of-Eight* (#77), to make 7 pieces, greatly increasing the difficulty. Two made in 1990. See *PWPD*, Chapter 21.

78-A. **Pillars of Hercules**. Similar to the *Pillars of Hercules* (#78) except that the three apparent pieces all break in two, making six puzzle pieces. Trickier, since one piece must be assembled last and come apart first. Three made in 1990.

78-B. **Pillars of Hercules**. Another variation of the *Pillars of Hercules* (#78) in which, instead of coming apart, two of the pieces have rotating joints, made using countersunk flat-head screws, with the screw heads hidden by glue joints. Two made in 1990.

78-C. **Five-Piece Solid Block Puzzle**. Just an ordinary 5-piece dissection of the 3x3x3 cube. What makes it different from most is that if accurately made it tends to be interlocking, depending upon one's definition of interlocking, and surprisingly confusing. Two made in 1990. See *PC*'92.

78-D. **Pretty Puzzle**. Another 5-piece dissection of the 3x3x3 cube, this one not very difficult but if made of colorful contrasting woods has symmetrical patterns on the faces. One made in 1990.

79. **Triple Cross**. Among the various possibilities of using larger pieces with the type of joint used in the *Pieces-of-Eight*, this particular one used 12 or 14 pieces assembled in the familiar *Altekruse* configuration. Two made in 1973. See *PWPD*, Chapter 21, page 165.

80. **Thirty Pinned Pentagonal Sticks**. This creation uses 30 identical pentagonal sticks pinned together with 30 dowels into a sort of spherical cluster. Each stick has 7 holes. It could be considered a geometrical construction kit, not too difficult if you have an illustration of the assembly to follow. About 20 made, 1987-1988. See *PWPD*, Chapter 17.

80-A. **Thirty Pinned Pentagonal Sticks** (smaller 5-hole version) The sticks are shortened and the two end holes omitted. One made in 1988. See *PWPD*, Chapter 17.

80-B. *Thirty Pinned Pentagonal Sticks* (even smaller 3-hole version). One made in 1988. See *PWPD*, Chapter 17.

81. *Nest Construction Set*. This idea was proposed as an extension of the scheme used in the Locked Nest. No sets were ever produced - only a few experimental pieces. See *PWPD*, Chapter 13.

81-A, 81-B-1, 81-C-1. *Two-Three, Four-Legged Stand* and *Double Four-Legged Stand*. These were all minor variations of the *Nest Construction Set* (#81). See *PWPD*, Chapter 13.

82. *Patio Block*. Eight pieces, each one consisting of 1x2x2 rectangular blocks joined different ways, assemble to form a 4x4x4 cube with external symmetry. The idea for this came to me in a publication by Ric van Grol, which attributes the original 10-piece design to Toshiaki Betsumiya and an 8-piece version to Kevin Holmes. Four made in 1988. See *PWPD*, Chapter 3 and *PC'92*.

83, 83-A *Pentagonal Stand*. Five identical pentagonal sticks are held together with five dowels. In the "A" version, two of the dowels are fixed in place to make two elbow pieces. The assembly has five-fold symmetry. About 20 made in 1990. See *PWPD*, Chapter 17.

84 *Obstructed Pins*. This could be considered a variation of *Locked Nest* (#22), with three holes in each of the 12 sticks rather than five, and no elbow pieces. Three of the sticks are slightly shorter at one end, allowing three dowels to be removed to begin disassembly. Two made in 1988.

84-A. *Unnamed*. This is a 30 pentagonal stick version of the *Obstructed Pins* (#84). Details of the design were never recorded. Only one made in 1988, now in California.

85. *Twelve-Piece Separation*. Twelve triangular sticks with pyramidal end blocks attached assemble with some difficulty to form an interlocking symmetrical burr. Fully described in *PC'92*, including solution. About 30 made, 1988-1992. A 1997 version was 10% smaller with fancy woods, 5 made.

85-A. *Geodynamics*. This is a variation of the a *Twelve Piece Separation* (#85) where it has been distorted by expansion along one orthogonal axis and compression along another - i.e. from cubic to brick shaped. To put it another way, all the sticks are of 50-60-70-degree cross-section. Very confusing to assemble, but the pieces are lettered in conjunction with printed solution. Difficult to make, requiring many complicated saw jigs. Thirteen made in 1994. There was a variation made of the *Geodynamics*, which my notes indicate had additional blocks for even greater confusion, details not recorded. One made of Sitka spruce around 1990, now in England.

Note: From here on, regrettably many of the descriptions will be found to be lacking in sufficient detail to serve as directions for making them. The reason for this is that we now enter a phase of AP-ART in which many of the designs involve distortions, weird angles, or other complications - hard to design, even harder to make (not to mention solve!), and beyond my patience to attempt to illustrate.

86. *Four-Piece Separation*. A derivative of *Twelve Piece Separation* (#85). Four simple pieces, very easy, just a novelty. Four made in 1988.

86-A. *Three-Piece Separation*. Another variation of *Twelve Piece Separation* (#85), coordinate motion. One made in 1988.

87. *Two-Sided Tray*. This was a six-piece diagonal dissection of the square. It came with a two-sided tray, square on one side and rectangular on the other. One made for Atlanta museum exhibit in 1992 and lost there. For improved version, see *Quadrilateral* (#87-A).

87-A. *Quadrilateral*. This is an improved 7-piece variation of the *Two-Sided Tray* (#87). It is fully described in *PC'92*. Designed in 1989 and produced for a while in the early 1990's by Trench Enterprises in England.

88. *Little Rocket*. Six pieces made up of triangular blocks assemble to form solid rhombic dodecahedron, with square cupped stand to hold them together. Ten made, 1989-1990 (to use up scrap blocks left over from other projects).

89. *Cylindrix*. This was to be a variation of *Hexsticks* (#25-A), using round dowels rather than hexagonal. One rough model made long ago, which may still be around somewhere.
90. *Permutated Four Corners*. As the name suggests, this was a variation of *Augmented Four Corners* (#34). Two were made and sold in 1990, but the design was never recorded and I have forgotten the construction.
91. *Pinned Triangular Sticks*. Evidently this was to be a variation on *Hexsticks* (#25-A) in which the 12 triangular sticks were held together with pins rather than notches. Never carried to fruition.
92. *Queer Gear*. Six pieces assemble to form a Star of David prism. A few made around 1985. See *PWPD*, Chapter 16.
- 92-A. *Second Gear*. This is a variation of *Queer Gear* (#92) in which the vertical axis has been compressed by 22%, changing all the angles and greatly complicating construction. Colorful wood combinations used. Eight made in 1996.
93. *Unnamed*. A four-piece serially interlocking 3x3x3 cubic block dissection. Three made in 1992.
94. *Fourth Dimension*. This is a derivative of *Pennydoodle* (#67-B). The four pieces (two of each kind) assemble with coordinate motion two different ways, making either a square or tetrahedral form. Must be made accurately and of stable woods to work satisfactorily. Otherwise would have made more. Four made in 1991.
95. *All Star*. This is an extension of *Star-of-David* (#37). The six dissimilar pieces assemble to form three different solids having three-fold symmetry plus two solids having reflexive symmetry. About 10 made in fancy woods starting in 1990, the more recent ones being scaled down about 10% from the original.
96. *Teddy Burr*. This design is derived from the standard *Six-Piece Burr* having five type-2 pieces and one type-3 piece (see *PWPD*, Chapter 5), except that the three orthogonal axes are all skewed by 5 degrees, making assembly slightly more confusing. Eight made in 1993.
- 96-A. *Grizzly Burr*. Another variation of the standard *Six-Piece Burr*, but in this one all three pairs of sticks are rotated 5 degrees from their orthogonal positions, making the solution surprisingly confusing. About 30 made in 1994.
- 96-B. *Double Notch* (aka *Grin 'N Burr It*). Superficially similar to the *Grizzly Burr* (#96-A), but the double notch feature requires additional shifts to assemble, making it even more confusing. Used as an exchange puzzle at IPP-16.
97. *Crooked Notches*. This design is derived from the familiar six-piece *Diagonal Burr*, which has been compressed along one of its 3-fold axes, making the sticks rectangular rather than square and the notches crooked. Used as an exchange puzzle at IPP-14.
- 97-A. *Rectangular Faces*. To visualize this design, take design *Square Face* (#74), and distort it as with *Crooked Notches* (#97). Two made in 1994.
98. *Yogi Burr*. More complicated and confusing than either *Teddy Burr* (#96) or *Grizzly Burr* (#96-A), combining the features of both. Also the most difficult to craft. Several made in 1994.
- 98-A. *Slant Six*. Similar to *Yogi Burr* (#98) but more symmetrical and even more confusing. Several made in 1994 of padauk.
99. *Disinclination*. This can be visualized as *Seven Woods* (#42) that has been distorted by compression along one of its three-fold axes, making the faces rectangular rather than square and changing all the angles, very similar to *Crooked Notches* (#97). A few made in 1994.

100. **Concentrix**. A variation of **Hectix** (#25). Experimental model made around 1993 by machining down styrene **Hectix** (#25) pieces. Has the intriguing shape of two concentric first stellations of the rhombic dodecahedron.
- 100-A. **Meteor**. A variation on the **Concentrix** (#100). Twelve pieces form an interlocking stellated burr in somewhat the same way as **Hexsticks** (#25-A), although with a completely different shape. Made only one rough model in 1994, with the intention of making more of this intriguing design sometime.
101. **Isosceles**. A 12-piece burr made with triangular sticks and triangular end blocks, distorted by compression along one of its four-fold axes. A few made in 1994.
- 101-A. **Iso-Prism**. This is a variation of the **Isosceles** (#101) in which additional end blocks are used to make the eight end faces solid triangles. Even more confusing to solve. A few made in 1994.
102. **Incongruous**. This is an unusual variation of the familiar six-piece **Diagonal Burr** in which the sticks have rhombic cross-section and require coordinate motion to assemble. One piece has a third notch. Used as an exchange puzzle at IPP-15.
- 102-A. **Redemption**. This is a variation of the **Incongruous** (#102) in which two of the pieces have a third notch, yet it still requires coordinate motion to solve. Rough model made in 1995, but needs some further work.
103. **Missing Piece!** Uses five dowels and five pins, and forms a pentagonal ring. The individual pieces somewhat resemble those of the six-dowel **Pin-Hole** (#20), but with a piece missing, hence the name. Used as an exchange puzzle at IPP-16.
104. **Tech Sticks**. This is a variation of **Hexsticks** (#25-A) in which brick-like distortion has been applied to two orthogonal axes, as with **Geodynamics** (#85-A). Regard it as a hobby exercise in solid geometry and woodworking. Seven made in 1995.
- 104-A. **Tech Sticks** (four contrasting woods). Two made in 1995.
105. **Lock Nut**. An unusual variation of the six-piece **Diagonal Burr**, with rectangular cross-section pieces, requiring coordinate motion to assemble. Used as an exchange puzzle at IPP-16.
106. **Burr Noodle**. Has superficial resemblance to the standard six-piece **Diagonal Burr**, but the rhombic cross-section sticks and weird angles make it extremely baffling to assemble. Made in paduk and used as an exchange puzzle at IPP-17.
- 106-A. **Reluctance**. This was a more non-symmetrical version of the **Burr Noodle** (#106). The original **Burr Noodle** appeared to be the better design of the two, so this one never got beyond the one 1995 experimental model.
107. **Trillium**. A distorted version of the standard six-piece **Diagonal Burr**. Two kinds of pieces, three of each, which assemble by mating two mirror-image halves. Used as an exchange puzzle at IPP-16.
- 107-A. **Augatron**. An augmented version of **Trillium** (#107). Additional end blocks make the six faces solid rectangles. Four made in 1995.
108. **Nonesuch**. A distorted version of **Four Corners** (#6), compressed along one axis. A couple experimental models were shown around in 1995 for possible use as exchange puzzles, but never used (for good reason, uninspired design).
109. **Slocum-Pokum**. A distorted version of **Pin-Hole** (#20). Used as an exchange puzzle at IPP-16. Sticks are rhombic cross-section.
- 109-A. **Foul Dowel**. Same as the **Slocum-Pokum** (#109) except made with round dowels. One experimental model made in 1995.

110. **Octo Burr**. An unusual 8-piece burr made with square sticks and crooked notches. Some sticks joined in pairs. Used as an exchange puzzle at IPP-17.
111. **Lost & Found**. A six-piece **Diagonal Burr** with identical pieces goes together in two halves, yet requires coordinate motion to assemble. My original model, dated 1973, was put away and forgotten until rediscovered recently. Five made in 1995.
- 111-A. **Lucky Star**. Functionally same as the **Lost & Found** (#111), but additional blocks give it the shape of **Vega** (#46). Six made in 1995.
- 111-B. **Star Dust**. Likewise functionally like **Lost & Found** (#111), but additional blocks give it the shape of the third stellation of the rhombic dodecahedron. Two made in 1995.
- 111-C. **A-B-C**. Has a superficial resemblance to **Star Dust** (#111-B), but has three kinds of pieces, two of each. The name is intended to mislead. Four made in 1995-1997.
- 111-D. **Unnamed**. Like **Lost & Found** (#111), but two kinds of pieces, three of each. One made in 1995.
112. **Burr Muda**. Has same shape as **Triangular Prism** (#12), but six identical pieces require coordinate motion and dexterity to assemble. Ten made in 1995.
113. **Sliparoo** (aka **Dexterium**). Similar to the **Burr Muda** (#112) except the square ends of the pieces give it a different appearance and make it perhaps even more frustrating to assemble. Used as an exchange puzzle at IPP-17.
114. **Cluster Plus**. Has a superficial resemblance to **Cluster Buster** (#49), but that is where the similarity ends. Six dissimilar, non-symmetrical pieces, difficult to disassemble and even more baffling to reassemble. Eleven made around 1996, of which five were given out as tokens at IPP-17.
115. **Fancy This!** A 7-piece serially interlocking burr, made in four contrasting fancy woods which, being symmetrically arranged, aid the otherwise very difficult solution. Eight made in 1996.
- 115-A. **Fancy This!** A more difficult version of the **Fancy This!** (#115) made in plain wood by Interlocking Puzzles and used as an exchange puzzle at IPP-17.
116. **Burr Circus**. A six-piece **Diagonal Burr** made with square sticks skewed. Six made in 1995.
117. **Overdrive**. Third (and last) of the "Gear" family of designs, this one involves coordinate motion of all six pieces to assemble. Came with assembly jig. Five made of teak in 1996.
118. **Three Bunnies**. Three dissimilar pieces assemble with coordinate motion to form a triangular three rhombic dodecahedron cluster. Used as an exchange puzzle at IPP-18.
119. **Cluster's Last Stand**. This **Six-Piece Burr** design bears a superficial resemblance to others in the **Cluster Buster** (#49) family, but its tricky assembly has baffled experts. About 18 made in 1996-1997.
120. **Nine-Piece Pentagon**. Nine dissimilar pieces fit into a pentagonal tray. Six made of ¼-inch plywood in 1996. A laser-cut version made by Walter Hoppe was used as an exchange puzzle at IPP-17.
121. **Pentagonal Star**. Thirteen dissimilar pieces fit into a tray having the shape of a pentagonal star. Four made of ¼-inch plywood in 1996. Some of these have also been laser-cut by Walter Hoppe.
122. **Rhombic Blocks**. Nine pieces representing all possible ways that three rhombuses can be joined together fit into a hexagonal tray. Analysis by computer has shown 14 solutions. Made in nine contrasting fancy woods. Ten made in 1996.
123. **Abel's Chimney**. A solid nearly cubic block is dissected by three diagonal cuts to make eight puzzle pieces which fit snugly inside a nearly cubic box, but alas with a ninth rectangular block left over. The problem is to rearrange the blocks so that the ninth block fits in too, made even more difficult by interchanging pieces between sets so that the grain of the wood is no help. Four made in 1997.

124. **R-D-16**. This is a continuation of the series represented by designs **Four-Piece Pyramid** (#26) and **Octahedral Cluster** (#31). Sixteen rhombic dodecahedron blocks are joined together to make four puzzle pieces which assemble into a symmetrical interlocking polyhedral cluster. Four made in 1997.
125. **Archimedes Tile**. Seven pieces made of squares and triangles joined together different ways fit into square tray. One made in 1997. Not very good.
126. **Stew's Scrap Pile**. A hybrid **Six-Piece Burr** which has characteristics of both the standard square burr and the **Diagonal Burr**. Used by as an exchange puzzle at IPP-17.
127. **Make Room**. A set of eight rectangular blocks appears to fit snugly into a 7x9x11 box, and the problem is to also fit the left-over ninth block in. One made in 1997.
- 127-A. **Make Room** (larger variation). In a 9x10x11 box. One made in 1997.
128. **Combination Lock**. This unusual design could be considered a modified version of the **Rosebud** (#39). Main difference - all pieces are dissimilar and go together with coordinate motion one way only. The assembly jig for Rosebud can also be used for this one. Six made in 1997.
129. **Dudd**. Appears to be an impossible version of the standard **Six-Piece Burr**, but with some superfluous diagonal notches added. There are several variations, depending upon the number and arrangement of diagonal notches. Six is the minimum. Six made in 1997.
- 129-A. **Missing Notches Burr**. This particular version of the **Dudd** (#129), with 10 extra notches, was used as an exchange puzzle at IPP-18.
130. **Slider**. A six-piece **Diagonal Burr** made with rhombic sticks that requires coordinate motion to assemble. Two mirror-image types of pieces, three of each. Five made in 1997.
131. **Six of Diamonds**. Similar to the **Slider** (#130) except that all six pieces are dissimilar. Reported to be extremely difficult. Made in padauk and used as an his exchange puzzle at IPP-18.
132. **Tectonic**. A **Six-Piece Burr** which combines all three techniques used in the #96 and #98 series of skewed burrs to make them confusing - rotation and slant in two different directions Previous designs used only one or two. (Where to go from here?) Used as an exchange puzzle at IPP-18.
133. **Few Tile**. Four simple pieces fit into a rectangular tray. Some puzzle experts have declared it impossible! Used as an exchange puzzle at IPP-18.
134. **Outhouse**. Five blocks fit into a constricted square tray by a series of shifts. A slightly modified version (with different name!) was made in England and used as an exchange puzzle at IPP-19. Either design error or inaccuracy in manufacture allowed easier false solutions which defeated the purpose of the design.
135. **Unnamed**. Seven irregular hexagons fit into a hexagonal tray. This design remains unfinished.
136. **Tangram Plus**. Looks like the familiar 7-piece **Tangram** but will not fit into the square tray in the usual way. The rhomboid piece is too long! Six made in 1998.
- 136-A. **Tangram Plus** (alternate version). In this one the rhomboid piece is too fat. One made in 1998. May have been used as an exchange puzzle at IPP-19.
137. **Engelberg Square**. Six polyomino-type pieces made with corner-beveled squares fit onto a square tray. Six made in 1998.
138. **Piggy Box**. A 3-D shifting block packing puzzle. Five types of pieces are made of cubes joined together different ways. Rectangular box has rectangular hole on top for insertion of pieces, with round holes in sides for manipulating them inside. Various problems with different combinations of pieces. Eight made in 1998.

139. *Unnamed*. Nine puzzle pieces made up of 54 triangular tiles joined different ways fit into hexagonal tray. A joint venture with computer help from Nick Baxter and Mike Beeler. So far only rough models made.

140. *Sticky Sticks*. Looks just like *Hexsticks* (#25-A) when assembled, but eight of the pieces are joined in pairs to make four compound pieces. This greatly increases the difficulty, but use of four contrasting woods arranged symmetrically is big hint. Five made in 1998.

141. *Isosceles*. Ten puzzle pieces made up of isosceles right triangles joined different ways fit into square tray. Two contrasting woods used for artistic effect. Six made in 1998.

142. *Octahedron*. Seven polyomino-type pieces made of squares joined different ways fit onto a squat octahedron tray. A couple rough models made. Design may undergo some further modifications and improvements before becoming final.

Note. This completes the listing of AP-ART designs through December 1998. I regret that many of these descriptions are lacking in design details and drawings, especially the more recent ones, but the task of providing all of that would be overwhelming. I usually do not work from mechanical drawings, so creating these just for publication hardly warrants the great time and effort that would be required.

I have always encouraged others to copy my designs, either as a hobby or business. Many are now finding their way into the IPP puzzle exchanges. I have attempted to indicate which ones have already been used, but I expect that my notes are incomplete. I like to know when someone uses one of my designs for production, and I would appreciate receiving a few samples in exchange.

Castle Creations

Beginning in January 1999, my serial listing of AP-ART designs continues as before, but with the added by-name *Castle Creations*. This reflects a change in location from Lincoln to Andover and also a change in operations from a woodworking enterprise involving production and sales to a part-time hobby limited to designing, model making, and publishing. Incidentally, the name *castle* derives from the utility structure that I designed and built in our backyard here in Andover.

143. *Checkout*. Twelve checkered pieces made up of isosceles right triangles fit into a square tray. Used as an exchange puzzle at IPP-20.

143-A. *Checker*. Same idea as *Checkout* (#143), but only nine pieces.

144. *Windmill*. Same idea as *Checkout* (#143) and *Checker* (#143-A) but larger and more difficult, 17 dissimilar pieces. Several minor variations are possible using multi-colored pieces to create solutions with symmetrical patterns.

145. *Lemon*. Ten colorful pieces made up of isosceles and equilateral triangles fit into elliptical tray.

146. *Lime*. Similar to *Lemon* (#145) except 10 pieces made up of isosceles right triangles and 30-60-90 triangles fit into elliptical tray. Used as an exchange puzzle at IPP-19.

147. *Pineapple*. Similar to *Lemon* (#145) and *Lime* (#146) but larger and more complicated, with 13 pieces made up of squares and equilateral triangles.

148. *Fourteen-piece Square*. This little novelty was made as a handout for an Elderhostel puzzle workshop in Lenox, MA in April 1999. Six triangular pieces and eight polyomino-types fit into square tray.

149. *Five-piece Garnet*. (with coordinate motion). This and *Five-piece Garnet* (#150) were experimental variations of the original *Garnet* (#60). I prefer the original six-piece design.

150. *Five-piece Garnet*. See *Five-piece Garnet* (#149).

151. *Two-Tiers with Scorpius Outer Shell*. Outer shell is *Scorpius* (#5), and inner is *Garnet* (#60). Intriguing and confusing, but hard to make, so only made two.
152. *Seven-piece Scrambled Scorpius*. Several variations found, but none very satisfactory, so call it still unfinished.
153. *The Trap*. Four trapezoidal pieces fit into a nearly square tray.
154. *Unnamed*. This abortive design was to have been similar to *Outhouse* (#134) but involving coordinate rotation of all four pieces. I have yet to find a design that does not have unwanted solutions, so unfinished.
155. *Eight-piece Tangram*. Looks like a standard *Tangram* but pieces must be rearranged to accommodate extra triangular piece in slightly oversized tray. Used as an exchange puzzle at IPP-20.
156. *Sphinx*. This could be considered a sequel to *Jupiter* (#7) and *Saturn* (#24). Twelve dissimilar pieces fit together one way only, and in essentially one order. Several variations are possible depending upon the arrangement of dissimilar woods. This version, by far the most difficult, uses all one wood.
- 156-A. *Sphinx*. This version uses 5 dissimilar woods in matched pairs, with the pairs arranged in what I call cubic symmetry. This greatly facilitates the solution.
- 156-B. *Sphinx*. This version uses 15 dissimilar woods in matched pairs, with the pairs arranged opposite each other. This is the easiest of the three versions.
157. *Egyptian* (4 woods). A multi-color version of *Egyptian* (#23-A).
- 157-A. *Egyptian* (3 woods). A multi-color version of *Egyptian* (#23-A).
- 157-B. *Egyptian* (2 woods). A multi-color version of *Egyptian* (#23-A).
- 157-C. *Egyptian* (6 woods). A multi-color version of *Egyptian* (#23-A). In all of the #157 *Egyptians*, the dissimilar woods are arranged symmetrically, which aids the solution.
158. *Augmented Scorpius* (with coordinate motion). A practical design for this intriguing idea has so far not been found, and may not even exist.
159. *Seven-piece Hexsticks*. An improved version of a design first listed as *Sticky Sticks* (#140), which this one replaces. All but two of the ordinary Hexsticks pieces are joined in pairs. Reported to be very difficult.
160. *Venus*. This is a variation of the old *Design Number 72* (#72), which has the assembled shape of a triacontahedron. This particular version uses 10 woods, one for each piece.
- 160-A. *Venus* (5-woods). Same as *Venus* (#160) except two pieces of each wood.
- 160-B. *Venus* (5-woods, matched pairs). Unlike *Venus* (#160-A), these dissimilar woods are symmetrically arranged, facilitating the solution.
- 160-C. *Venus* (6-woods). Dissimilar woods arranged in what I call double pinwheel symmetry, slightly easier than the *Venus* (#160-B).
- 160-D. *Venus* (1 wood). This would be the most difficult version if one were to be made.
161. *New Garnet*. This is just a new edition of the old No. 60, Garnet, larger and more accurately made.
162. *Scrambled Legs*. Similar in principle to the *Scrambled Scorpius* (#23), but having the assembled shape of the third stellation of the rhombic dodecahedron. Just one more example, if any is needed, of how the same idea gets recycled over and over. The only one made was used for the logo prize awarded at IPP-20.
163. *Unnamed*. Five rectangular blocks fit into a rectangular tray - this proved to be unsatisfactory and has been shelved.

164. *Scrambled Scorpius* (4 woods). More colorful than the original *Scrambled Scorpius* (#23) because of the four contrasting fancy woods, and easier because of the color symmetry.

164-A. *Scrambled Scorpius* (6 woods). One wood for each piece, so more colorful than the original *Scrambled Scorpius* (#23) but just as difficult.

164-B. *Scrambled Scorpius* (6 woods). In this 6-wood version the woods are arranged symmetrically with no like colors touching, so somewhat easier than the *Scrambled Scorpius* (#164-A)

165. *Split Star* (simplified version). This modified version of the *Split Star* (#75) is easier to make than the original and also stronger because the inner and outer blocks are joined by full faces rather than half faces. This construction lends itself to sculptural recreations by selectively removing some outer blocks, as in the *Diminished Split Star* variations.

165-A. *Diminished Split Star* (hexagonal column).

165-B. *Diminished Split Star* (square column).

165-C. *Diminished Split Star* (octahedral).

165-D. *Diminished Split Star* (triangular).

165-E. *Diminished Split Star* (six-pointed star).

166. *Shouldered Scorpius*, simple version. Resembles the old *Scorpius* (#5), but the added shoulders restrict movement to one axis.

166-A. *Shouldered Scorpius, three plus three version*. All six pieces identical but non-symmetrical. Tricky solution requires coordinate motion.

166-B. *Shouldered Scorpius, symmetrical version*. All six pieces identical and symmetrical. Solution requires coordinate motion.

167. *Four Pieces In A Tray*. Four simple pieces, two trapezoidal and two triangular, fit onto a rectangular tray. Laser cut by Walt Hoppe and used as an exchange puzzle for IPP-20.

Part 3 - Appendix

AP-ART Designs and Castle Creations Used In IPP Puzzle Exchanges

Note: This list may not be complete.

IPP-14

Crooked Notches (#97)

Four Corners (#6)

IPP-15

Incongruous (#102)

Leaning Tower of Altekruise (#68-A)

IPP-16

Button Box (#52-B)

Cornucopia (#76-B)

Double Notch (#96-B)

Lock Nut (#105)

Missing Piece! (#103)

Slokum-Pokum (#109)

Trillium (#107)

IPP-17

Burr Noodle (#106)

Fancy This! (#115-A)

Nine-Piece Pentagon (#120)

Octo Burr (#110)

Sliparoo (#113)

Stew's Scrap Pile (#126)

Three Bunnies (#118)

IPP-18

Few Tile (#133)

Frantix (#9-A)

Missing Notches (#129-A)

Six of Diamonds (#131)

Tectonic (#132)

Triangular Prism (#12)

IPP-19

Engelberg Square (#137)

Fusion Confusion (#15-A)

Lime (#146)

Outhouse (#134)

Tangram Plus (#136)

Three Pairs Variation (#27-A)

Windmill (#144)

IPP-20

Checkout (#143)
Eight-Piece Tangram (#155)
Four Pieces In A Tray (#167)

Complete List of AP-ART Instructions, Descriptions, and Other Printed Matter

- 1, The *Ortho-Cube* Puzzle, 1970, 1 page*
- 1-A, *The Cube* Puzzle, 1971, 1 page*
- 2, The *Pentablock* Puzzle, 1970, 1 page*
- 3, *Snowflake*, 1971, 10 pages¹, *
- 3, *Snowflake* Puzzle Worksheet, 1 page
- 4, *Sirius*, The Star Puzzle, 1971 & 1972, 1 page*
- 5, The *Spider-Slider* Puzzle, 1970, 1 page
- 5, *Scorpius*, 1971, 1 page
- 6, The *Four Corners* Puzzle, 1971, 1 page*
- 7, *Jupiter*, 1971, 1 page*
- 7, The *Jupiter* Puzzle, 1985, 1 page*
- 8, The *Nova* Puzzle, 1972, 1 page
- 8-B, Four-Color *Nova*, 1986, 1 page
- 9, The *Square Knot* Puzzle, 1972, 1 page
- 9, The *Square Knot* Puzzle (supplement for new version), 1986, 1 page
- 12, The *Triangular Prism* Puzzle, 1980, 1 page*
- 13-B, *Ring of Diamonds* Puzzle, 1995, 1 page
- 14-A, The *Second Stellation* Puzzle, 1980, 1 page
- 14-A, The *Second Stellation* Puzzle, 1984, 1 page
- 15, *Triumph*, 1974, 1 page
- 15-A, The *Fusion-Confusion* Puzzle, 1990, 1 page
- 18, *Abbie's Waffle* Puzzle, 1975, 1 page
- 19, *Pyracube*, 1975, 2 pages,
- 21, The *Cuckoo Nest* Puzzle, 1977, 1 page
- 21, Assembly directions for the *Cuckoo Nest* puzzle, 1990, 1 page*
- 22, The *Locked Nest* Puzzle, 1977, 1 page
- 22, The *Locked Nest* Puzzle (solution to six-elbow version), 1977, 1 page*
- 23, The *Scrambled Scorpius*, 1978, 1 page
- 23-A, The *Egyptian* Puzzle, 1993, 1 page*
- 24, The *Saturn* Puzzle, 1978, 1 page*
- 25-A, The *Hexsticks* Puzzle, 1979, 1 page*
- 25-B, *Giant Hectix*, 1993, 1 page*
- 25-C, *Four-Color Hexsticks*, 1995, 2 pages,
- 26, The *Four-Piece Pyramid* Puzzle, 1979, 1 page*
- 27, The *Three Pairs* Puzzle, 1979, 1 page*
- 28, *Truncated Octahedra* Puzzle, 1979, 2 pages,
- 29, The *Half-Hour* Puzzle, 1980, 1 page
- 29, The *Half-Hour* Puzzle (21 problem shapes), 1983, 1 page
- 30, The *Convolution* Puzzle, 1980, 1 page*
- 31, The *Octahedral Cluster* Puzzle, 1980, 1 page
- 32, The *Broken Sticks* Puzzle, 1980, 1 page*
- 33, The *Twelve Point* Puzzle, 1980, 1 page
- 33, The *Twelve Point* Puzzle, 1984, 1 page
- 34, *Augmented Four Corners* Puzzle, 1981, 1 page

35, 36 & 40, *Six-Piece Burrs*, 1981, 3 pages,
 35, Solution to *Burr 305*, 1984², 1 page*
 37, The *Star-of-David* Puzzle, 1981, 1 page
 37, The *Star-of-David* Puzzle, 1990, 1 page*
 37-A, The *Star-of-David* Puzzle, improved, 1990, 2 pages*
 39, The *Rosebud* Puzzle (obsolete), 1982, 1 page
 39 & 39-A, The *Rosebud* Puzzle, 1983, 1 page*
 40, The *Interrupted Slide*, 1982, 1 page
 41, The *Unhappy Childhood* Puzzle, 1983, 1 page
 42, The *Seven Woods* Puzzle, 1971, 1 page*
 43 & 44, The *Sleeper-Stoppers*, 1972, 1 page
 43, 44 & 45, *Sleeper-Stoppers* and The *Buttonhole* Puzzle, 1984, 1 page
 52, The *Pennyhedron* (revised), 1984, 1 page
 53-56, Supplement to *Square Knot*, 1973, 1 page
 60, The *Garnet* Puzzle (obsolete), 1984, 1 page
 60, The *Garnet* Puzzle, 1985, 1 page
 61, The *Setting Hen* Puzzle, 1984, 1 page
 61-A, The *Distorted Cube* Puzzle, 1988, 1 page
 61-A, The *Distorted Cube* Puzzle, 1996³, 1 page
 62, The *Nine Bars* Puzzle, 1983, 1 page
 62, The *Nine Bars* Puzzle, 1990, 1 page*
 65-A, *Thirty Notched Rhombic Sticks*, 1987, 1 page*
 67, The *Peanut* Puzzle, 1988, 1 page
 67-B, The *Pennydoodle* Puzzle, 1989, 2 pages,
 68, The *Confessional* Puzzle, 1994, 1 page
 68, Analysis and Solution to The *Confessional* Puzzle, 1994, 2 pages, *
 68-B, *Confessional*, long version, 1995, 1 page*
 71, *Stucksticks*, 1995, 1 page
 73-A, *Seven-Piece Third Stellation*, 1996, 1 page*
 74 & 74-A, *Square Face* Puzzle, 1990, 1 page
 76, *Cornucopia*, 1985, 2 pages⁴,
 76, *Cornucopia* Kit, 1985, 1 page
 77, *Pieces-of-Eight Puzzle*, 1986⁵, 2 pages,
 77, *Pieces-of-Eight Puzzle* (supplement), 1986, 2 pages
 80, *Thirty Pentagonal Sticks*, 1987, 1 page
 81-A, The *Two-Three* Puzzle, 1987, 1 page
 81-B & 81-B-1, *Four-Legged Stand*, 1987, 1 page
 81-C & 81-C-1, *Double Four-Legged Stand*, 1987, 1 page
 83 & 83-A, *Pentagonal Stand* Puzzle, 1990, 1 page
 85, *Twelve-Piece Separation* Puzzle, 1988, 1 page
 85, *Twelve-Piece Separation* Puzzle (assembly directions), 1990, 1 page*
 85-A, The *Geodynamics* Puzzle, 1994, 1 page
 85-A, *Geodynamics* assembly instructions, 1995, 1 page*
 87, *Modified Five-Piece Puzzle*, 1992, 1 page*
 87-A, *Quadrilateral* Puzzle, 1992, 1 page*
 92, 92-A, *Queer Gear* and *Second Gear*, 1996, 1 page
 95, The *All Star* Puzzle, 1990, 2 pages, *
 96, 96-A & 96-B, Wild Burrs, 1994, 1 page
 97, *Crooked Notches*, 1994, 1 page
 97, *Crooked Notches* (revised), 1995, 1 page
 99, The *Disinclination* Puzzle, 1994, 1 page

- 101, The *Isosceles* Puzzle, 1994, 1 page
 101-A, The *Iso-Prism* Puzzle, 1994, 1 page
 102, The *Incongruous* Puzzle, analysis and solution, 1995, 1 page*
 103, The *Missing Piece* Puzzle, 1995, 1 page*
 104, *Tech-Sticks*, 1995, 2 pages,
 105, *Lock Nut*, 1995⁶, 1 page
 106, *Burr Noodle*, 1995, 1 page
 110, *Spare Pair*, 1996, 1 page
 111, A, B & C, *Lost & Found*, *Lucky Star*, *Star Dust* and *A-B-C*, 1995, 1 page
 112, *Burr Muda*, 1995, 1 page*
 112, *Burr Muda* Assembly Jig, 1996, 1 page*
 114, *Cluster Plus*, 1996, 1 page
 115 & 115-A, *Fancy This!*, 1996, 1 page
 117, *Overdrive*, 1996, 1 page*
 120, *Nine-Piece Pentagon*, 1996, 1 page*
 121, *Pentagonal Star*, 1996, 1 page*
 123, The *Chimney*, 1997, 1 page
 126, *Stew's Scrap Pile*, 1997, 1 page
 131, *Six of Diamonds*, 1997, 1 page
 134, *Outhouse*, 1998, 1 page
 136, *Tangram Plus*, 1998, 1 page
 138, *Piggy Box*, 1998, 2 pages
 140, *Sticky Sticks*, 1998, 1 page
 144, *Windmill*, 1999, 1 page*
 147, Plan for *Pineapple*, 1999, 1 page*
 156, *Sphinx*, 2000, 1 page
 156A, *Sphinx*, 2000, 1 page
 156B, *Sphinx*, 2000, 1 page
 157, Recycled *Egyptian*, 2000, 1 page
 159, *Seven-Piece Hexsticks*, 2000, 1 page
 160 & 160-A, *Venus*, 2000, 1 page
 160-B, C & D, *Venus*, 2000, 1 page
 161, *Garnet*, 2000, 1 page
 164, *Scrambled Scorpius*, 2000, 1 page
 166, *Shouldered Spider Slider*, 2000, 1 page

*Indicates that explicit assembly directions are included.

¹ Hexagon shaped booklet.

² Reprinted in 1995.

³ Revised 1996.

⁴ Before being folded.

⁵ Revised 1990.

⁶ Draft only.

Unnumbered and Miscellaneous Publications

Rec-Tangle, 1973, 1 page

Occ-Wood, 1973, 1 page

Instructions for Various AP-ART Puzzles, 1973, 1 page

Directions for Making *Jupiter-Saturn*, 1983, 1 page

Bill's Baffling Burr, 1984, 1 page

Bill's Baffling Burr, 1986, 1 page

The Blue Mahoe Story, 1 page

The *Third Stellation*, 1986, 1 page
Old Puzzle Serial List (obsolete), 1 page
Polly's Flagstones, 1993, 2 pages
Odyssey of the *Figure Eight* Puzzle, 1993, 2 pages
Anniversary Newsletter, 1995, 2 pages
Use of Multi-Colored Woods, 1995, 1 page
Serial List of AP-ART Puzzles, 1998, 5
Castle Creations, 1999-2000, 2 pages

Complete list of brochures issued

- 1970 *Ortho-Cube, Pentablock, Snowflake*
- 1971 *Sirius, Scorpius, Four Corners, Cube, Jupiter*
- 1972 *Sirius, Scorpius, Four Corners, Nova, Jupiter*
- 1974 *Star, Four Corners, Triumph, Super Nova, Square Knot, Giant Steps, Hex Prism, Triangular Prism, The General, Dislocated Scorpius, Jupiter, Dislocated Jupiter*
- 1975 Same as 1974 plus *Waffle, Pentablock, Pyracube*
- 1977 *Pin Hole* series, *Cuckoo Nest, Locked Nest, Snowflake, Pentacube, Jupiter*
- 1978 *Pin Hole* series, *Cuckoo Nest, Locked Nest, Snowflake, Scrambled Scorpius, Saturn*
- 1979 *Pin Hole* series, *Cuckoo Nest, Locked Nest, Snowflake, Scrambled Scorpius, Saturn, Hexsticks, Four-Piece Pyramid, Three Pairs, and Truncated Octahedra*
- 1980 (Supplement to 1979) *Half-Hour, Convolution, Octahedral Cluster, Triangular Prism, Broken Sticks*
- 1981 *Scrambled Scorpius, Saturn, Hexsticks, Four-Piece Pyramid, Three Pairs, Half-Hour, Convolution, Octahedral Cluster, Triangular Prism, Broken Sticks, Second Stellation, Twelve Point, Augmented Four Corners, Six-Piece Burr, Star-of-David, Snowflake, Truncated Octahedra*
- 1983 Three puzzle liquidation sale lists were issued in this year.
- 1984 *Garnet, Setting Hen, Pennyhedron, Nine Bars*
- 1984 Inventory list: *Snowflake, Second Stellation, Scrambled Scorpius, Hexsticks, Augmented Four Corners, Diagonal Cube, Garnet, Pseudo-Notched Sticks*
- 1984 Inventory list: *Snowflake, Scrambled Scorpius, Hexsticks, Twelve Point, Garnet*
- 1985 Inventory list: *Snowflake, Scrambled Scorpius, Hexsticks, Garnet*
- 1985 Inventory list: *Jupiter, Corner Block, Cornucopia*
- 1985 Inventory list: *Jupiter, Hexagonal Prism, Second Stellation, Triumph, Scrambled Scorpius, Four-Piece Pyramid, Three Pairs, Burr #305, Improved Cluster-Buster, Diagonal Cube, Garnet, Square Face, Cornucopia*
- 1985 Inventory list: *Jupiter, Hexagonal Prism, Second Stellation, Triumph, Corner Block, Garnet, Cornucopia*
- 1985 Special offer - *Cornucopia No. 105747*
- 1986 *Bill's Baffling Burr, Burr #305, Cornucopia*
- 1987 Boring Puzzles - *Four-Legged Stand, Double Four-Legged, Pentagonal Stand, Thirty Pentagonal Sticks*
- 1990 *Fusion-Confusion, Twelve-Piece Separation*

Magazine Articles on AP-ART

Dec. 6 1971 *New York*
July 1974 *Esquire*
Jan. 1978 *Scientific American*
Jan. 1979 *Fine Woodworking*
Fall 1984 *Abacus*
Nov. 1984 *Fine Woodworking*
Sept. 1985 *World of Wood*
Sept. 1985 *The Woodworker's Journal*
Sept. 1985 *The Lincoln Review*
Oct. 1985 *Scientific American*
March 1986 *The Woodworker's Journal*
Feb. 1987 *World of Wood*
May 1991 *Quark*
Dec. 1991 *Fine Woodworking*

Summary

Counting just the numbered, finished designs listed here, there are about 250, starting in 1970 and covering a span of 30 years. In my previous serial listings I included rankings to indicate which I considered to be the most (and least) satisfactory designs, both from my own perspective and as judged by others. I omit that ranking in this publication, but some of it can be inferred from the descriptions. Instead I have chosen to compile the following list in which I have chosen one favorite design to represent each special category of AP-ART puzzlement.

Jupiter (#7). This was always a favorite at craft shows and with customers, as mentioned in Part 1, although in my view more an example of woodcraft rather than a puzzle. The need for attractive woods in six contrasting colors led me into the wonderful new world of exotic tropical hardwoods and the International Wood Collector's Society.

Scrambled Scorpius (#23). Whenever you explore some new design idea, you find yourself up against the realities of the natural world. Seldom do things work out quite as you might wish, but here they surely did. The six dissimilar, non-symmetrical pieces conveniently proved to have only one solution and essentially only one order of assembly, even more difficult than I had intended. Recently I have made multicolored versions **Scrambled Scorpius** (#164) that are easier to assemble.

Hectix (#25) and **Hexsticks** (#25-A). This is where it all started. I have been asked many times: "How on earth did you ever come up with that idea?" No one was ever asked that about a checkerboard dissection. It is the surest indication of successful creativity that I can imagine. Incidentally, the closest analogy that I can think of in other fields of creative endeavor is not to be found anywhere in the art world but rather in classical music.

Triangular Prism (#13). This early design could be considered just a simple exercise in combinatorial mechanics. The intriguing geometrical solid that results is just one more example of the wonders which lie hidden in the natural world waiting to be discovered by some lucky explorer. Simple modifications to the underlying structure led to a large family of related designs.

Locked Nest (#22). I include this one as representative of the whole category of pinned sticks and my favorite among them, especially the 6-elbow version, of which only a few were made. There is something profoundly satisfying about joining things together with pins and holes. The first construction toy that I can remember from earliest childhood was a Tinkertoy set, and I rate it the best toy ever invented. Happily, they are still made - of wood, believe it or not, and practically unchanged from the original.

Four-Piece Pyramid (#26). This one is representative of the whole family of joined polyhedral block puzzles that are so utterly confusing to assemble. I could have chosen **Octahedral Cluster** (#31). Unfortunately they demand advanced woodworking skills for the required accuracy and are prone to breakage unless made with very strong glue joints. Some of mine had doweled joints for extra strength.

Rosebud (#39). Not my first satisfactory coordinate motion puzzle (that was **Three Pairs** (#27)), but long a favorite with puzzle collectors, especially the version made with Tulipwood and Rosewood. This was the first to include an assembly jig.

Confessional (#68-B). Of all my recent designs created by coordinate distortion, this was one of the most satisfactory and baffling. Too bad it was so hard to make. This is a good example of a familiar, century-old puzzle (Altekruse) which, by a simple modification, becomes something altogether new and different.

Twelve-Piece Separation (#85). Another example of how sometimes nature cooperates perfectly. I discovered the one surprising solution by using the old trick of first gluing it together assembled and seeing if it would come apart. It did, but just barely! For years I shunned including explicit assembly directions, but here I thought it was justified.

All Star (#95). We must include at least one that constructs multiple polyhedral shapes, extending the recreational potential. Others that might have been chosen instead are **Star-of-David** (#37), **Fusion-Confusion** (#15-A), or **Peanut** (#67). Only about ten of the **All Star** were made. In order to be entirely satisfactory, these types require very accurately made pieces using stable woods.

Burr Noodle (#106). Used as an exchange puzzle at IPP-17 and given out disassembled. It looks simple but I wonder how many were ever assembled. The design required some rather sophisticated (at least by my standards!) calculation of the bizarre angles. I might have carried out some of these mathematical calculations more adroitly 30 years earlier, but they keeps the brain cells exercised and I love doing it. How come it is that I, the analyst, who derives the most enjoyment from all of this, and not the paying public? It always struck me as strangely unfair.

Fancy This! (#115). A departure from previous designs, this unusual seven-piece polyhedral model is serially interlocking, meaning that all pieces are dissimilar and can be assembled in one order only, with a key piece completing the assembly. The multicolor symmetry provides helpful hints, but one version used as an IPP-17 exchange puzzle used all one wood for added puzzlement.

Cluster's Last Stand (#119). Another coordinate motion amusement but more sophisticated than any of the previous ones. And unlike most, it requires no dexterity, which can be a distraction. It emerged triumphantly from a long process of development and experiment, which included calculation of odd angles. If it had Edward Hordern stumped for over a month, it must be hard.

Few Tile (#133). This simple yet baffling four-piece puzzle is representative of some recent creations that rely for their success on exploiting the psychology of puzzle solving. In this example, force of habit will invariably lead one to start by fitting a square shape snugly into a square corner, which will immediately misdirect the hapless puzzle solver down a dead end path. Even better, the more experienced puzzle solvers are often the ones most likely to fall into this trap.

Sphinx (#156). This design evolved from a long line of development and experiment going all the way back to the Jupiter, which it very closely resembles in external appearance but not in other ways. The Jupiter was really just an intriguing sculpture in colorful woods that came apart. To make it somewhat more of a puzzle, the six dissimilar woods were arranged in color symmetry, and the problem was not only to reassemble it that way but to discover four other arrangements with less obvious color symmetry.

What I hadn't yet learned back then was that most persons don't like to follow complicated directions and will be content to just assemble it any way possible. That is how you will nearly always find them

assembled. Next in this line was the dislocated Jupiter in plain wood with identical but non-symmetrical pieces, somewhat more interesting to assemble. Only a few of these were made before being superseded by the Saturn puzzle, which had six pairs of dissimilar non-symmetrical pieces. It was supposed to have only one solution, but Stan Isaacs soon discovered a second.

In 1978, after much trial and error, I came up with what promised to be an improved design with twelve dissimilar non-symmetrical pieces, only one solution, and essentially only one order of assembly. A rough prototype was then made, which was put aside along with dozens of other experimental models and forgotten, only to be rediscovered twenty years later. In 1999 I made a few minor improvements and produced it as the Sphinx. It came in three slightly different versions, depending upon the number of dissimilar woods used and their symmetrical arrangement, which in most cases served as an aid to assembly.

Trusting that my assumption of only one possible solution holds up, I do not see any further improvement possible in this particular direction. The dozen or so of these that I have made were all with my most choice exotic woods (depleting my supply) and with doweled joints for added strength. If I had to choose just one example that best represents my AP-ART creations, I suppose this would be it. Ah, but then...

Reflections

As I write this, just thirty years have passed since my first AP-ART sale, which was on Nov. 27, 1970. It has been a bewildering exercise trying to summarize nearly half a lifetime of haphazard creative effort in these few pages. My grandchildren are older now than our children were when I began. I find myself widowed and living with someone else. My greenhouse/workshop in Lincoln now lies quiet and vacant, basking indifferently in the rays of departed glory. This amazing computer now commands more of my attention than any of my woodworking tools.

The emphasis in this publication has purposely been on the physical description of my various AP-ART designs. What is really more important, of course, is not the mechanical properties but what they represent in terms of discovery. The physical models could be regarded then as just the medium for conveying these fascinating recreations to someone else. As a practical matter, their sales to the public are what provided the income that keeps the whole enterprise going, as well as providing invaluable feedback. But above all else, at least in my experience, the artist is driven first and foremost by the sheer rapture of whatever it is that he or she does and the desire to share it with others. Then and only then comes the practical matter of mastering some technique through which to do it.

In looking back over my Summary list, I find that it is skewed in the direction of the baffling and confusing. Part of the reason for this is that recently much of my creative effort has gone into designing puzzles for the IPP puzzle exchanges. The harder the better, as far as those collectors are concerned. On the other hand, in my *Puzzle Craft* publications, one of the points I have tried to make is that often the simplest things turn out to have the greatest appeal for the general public.

There is a general misconception that we puzzle designers are bent on making our devices ever more diabolical and confusing. I was often asked at craft fairs which was my most difficult puzzle. To begin with, that question is impossible to answer because there are so many different kinds of difficulty. It is usually easy to make a puzzle more difficult simply by increasing the number of pieces, but for what purpose? Aside from the puzzle exchanges, I expect my puzzles to be assembled, and depending upon the situation, I have often included hints such as color symmetry to aid in the solution.

One final comment: I could never really figure out why people bought my puzzles, but I am deeply grateful for all their generous support over the years. For me, all the joy was in exploring for new ideas and developing them into practical working models. I encourage others to discover this fascinating world of geometrical recreations, especially children, and the younger the better.

Puzzle Name Index

- 111-C *A-B-C*
18 *Abbie's Waffle*
123 *Abel's Chimney*
95 *All Star*
125 *Archimedes Tile*
6-A *Aries*
107-A *Augatron*
34 *Augmented Four Corners*
158 *Augmented Scorpius*
14-B *Augmented Second Stellation*
42-A *Brickyard*
32 *Broken Sticks*
35 *Burr 305*
116 *Burr Circus*
112 *Burr Muda*
106 *Burr Noodle*
52-B *Button Box*
45 *Buttonhole*
143-A *Checker*
143 *Checkout*
114 *Cluster Plus*
119 *Cluster's Last Stand*
47 *Cluster-Buster*
36 *Coffin's Improved Burr*
128 *Combination Lock*
100 *Concentrix*
68 *Confessional*
30 *Convolution*
59 *Corner Block*
76 *Cornucopia*
97 *Crooked Notches*
66 *Crystal Blocks*
1-A *The Cube*
21 *Cuckoo Nest*
89 *Cylindrix*
54 *Defiant Giant*
72 *Design Number 72*
113 *Dexterium*
58 *Diagonal Cube*
4 *Diagonal Star*
165-A *Diminished Split Star*
99 *Disinclination*
17 *Dislocated Jupiter*
16 *Dislocated Scorpius*
61-A *Distorted Cube*
81-C *Double Four-Legged Stand*
96-B *Double Notch*
129 *Dudd*
23-A *Egyptian*
157 *Egyptian (Multi-Color)*
155 *Eight-piece Tangram*
137 *Engelberg Square*
64 *Expanding Box*
47-X *Experimental Cluster-Buster*
16-X *Experimental Dislocated Scorpius.*
14-X *Experimental Second Stellation*
75-X *Experimental Two Tiers*
115 *Fancy This!*
133 *Few Tile*
31-A *Five-Piece Octahedral Cluster*
78-C *Five-Piece Solid Block Puzzle*
149 *Five-piece Garnet*
109-A *Foul Dowel*
6 *Four Corners*
167 *Four Pieces In A Tray*
25-C *Four-Color Hexsticks*
81-B *Four-Legged Stand*
26 *Four-Piece Pyramid*
86 *Four-Piece Separation*
148 *Fourteen-piece Square*
94 *Fourth Dimension*
9-A *Frantix*
15-A *Fusion-Confusion*
60 *Garnet*
13 *The General*
85-A *Geodynamics*
25-B *Giant Hectix*
56 *Giant Pagoda*
10 *Giant Steps*
20-B *Goose*
96-B *Grin 'N Burr It*
96-A *Grizzly Burr*
29 *Half-Hour*
25 *Hectix*
11 *Hexagonal Prism*
25-A *Hexsticks*
25-D *Hectix*
52-A *Hole-in-One*
49 *Improved Cluster-Buster*
59-A *Improved Corner Block*
70 *Improved Saturn*
102 *Incongruous*
40 *Interrupted Slide*
101-A *Iso-Prism*
101 *Isosceles*
141 *Isosceles*
18-A *Joined Pairs*

7	<i>Jupiter</i>	87-A	<i>Quadrilateral</i>
20-A	<i>King Pin</i>	92	<i>Queer Gear</i>
68-A	<i>Leaning Tower of Altekruise</i>	124	<i>R-D-16</i>
145	<i>Lemon</i>	97-A	<i>Rectangular Faces</i>
146	<i>Lime</i>	102-A	<i>Redemption</i>
53	<i>Little Giant Steps</i>	106-A	<i>Reluctance</i>
88	<i>Little Rocket</i>	122	<i>Rhombic Blocks</i>
51	<i>Little Superstar</i>	13-B	<i>Ring of Diamonds</i>
105	<i>Lock Nut</i>	39	<i>Rosebud</i>
22	<i>Locked Nest</i>	39-A	<i>Rosebud Assembly Jig</i>
111	<i>Lost & Found</i>	24	<i>Saturn</i>
111-A	<i>Lucky Star</i>	5	<i>Scorpius</i>
127	<i>Make Room</i>	162	<i>Scrambled Legs</i>
100-A	<i>Meteor</i>	23	<i>Scrambled Scorpius</i>
129-A	<i>Missing Notches Burr</i>	164	<i>Scrambled Scorpius (Multi-Color)</i>
103	<i>Missing Piece!</i>	92-A	<i>Second Gear</i>
34-A	<i>Modified Augmented Four Corners</i>	14-A	<i>Second Stellation</i>
81	<i>Nest Construction Set</i>	61	<i>Setting Hen</i>
161	<i>New Garnet</i>	42	<i>Seven Woods</i>
62	<i>Nine Bars</i>	73	<i>Seven-Piece Third Stellation</i>
120	<i>Nine-Piece Pentagon</i>	159	<i>Seven-piece Hexsticks</i>
108	<i>Nonesuch</i>	152	<i>Seven-piece Scrambled Scorpius</i>
8	<i>Nova</i>	67-A	<i>Shatterblock</i>
84	<i>Obstructed Pins</i>	166	<i>Shouldered Scorpius</i>
31	<i>Octahedral Cluster</i>	22-B	<i>Siamese Locked Nests</i>
142	<i>Octahedron</i>	4	<i>Sirius</i>
110	<i>Octo Burr</i>	131	<i>Six of Diamonds</i>
1	<i>Ortho-Cube</i>	98-A	<i>Slant Six</i>
134	<i>Outhouse</i>	43	<i>Sleeper-Stopper</i>
117	<i>Overdrive</i>	130	<i>Slider</i>
55	<i>Pagoda</i>	113	<i>Sliparoo</i>
82	<i>Patio Block</i>	109	<i>Slocum-Pokum</i>
67	<i>Peanut</i>	3	<i>Snowflake</i>
67-B	<i>Pennydoodle</i>	156	<i>Sphinx</i>
52	<i>Pennyhedron</i>	5	<i>Spider-Slider</i>
52-C	<i>Pennyhedron Trick Pair</i>	75	<i>Split Star</i>
2	<i>Pentablock</i>	165	<i>Split Star, simplified version</i>
2-B	<i>Pentacube</i>	74	<i>Square Face</i>
83	<i>Pentagonal Stand</i>	9	<i>Square Knot</i>
121	<i>Pentagonal Star</i>	4-A	<i>Star</i>
90	<i>Permutated Four Corners</i>	111-B	<i>Star Dust</i>
77	<i>Pieces-of-Eight</i>	37	<i>Star-of-David</i>
138	<i>Piggy Box</i>	126	<i>Stew's Scrap Pile</i>
78	<i>Pillars of Hercules</i>	140	<i>Sticky Sticks</i>
20	<i>Pin-Hole</i>	71	<i>Stucksticks</i>
147	<i>Pineapple</i>	14	<i>Super Nova</i>
91	<i>Pinned Triangular Sticks</i>	44	<i>Super Sleeper-Stopper</i>
57	<i>Plus 2</i>	50	<i>Superstar</i>
78-D	<i>Pretty Puzzle</i>	50-A	<i>Superstar II</i>
63	<i>Pseudo-Notched Sticks</i>	136	<i>Tangram Plus</i>
19	<i>Pyracube</i>	104	<i>Tech Sticks</i>

132	<i>Tectonic</i>	15	<i>Triumph</i>
96	<i>Teddy Burr</i>	48	<i>Truncated Cluster-Buster</i>
50-B	<i>Third Stellation</i>	28	<i>Truncated Octahedra</i>
65-A	<i>Thirty Notched Rhombic Sticks</i>	85	<i>Twelve-Piece Separation</i>
65	<i>Thirty Notched Sticks</i>	33	<i>Twelve-Point</i>
80	<i>Thirty Pinned Pentagonal Sticks</i>	75-A	<i>Two Tiers</i>
118	<i>Three Bunnies</i>	81-A	<i>Two-Three</i>
27	<i>Three Pairs</i>	87	<i>Two-Sided Tray</i>
27-A	<i>Three Pairs Variation</i>	151	<i>Two-Tiers with Scorpius Outer Shell</i>
38	<i>Three-Piece Block</i>	41	<i>Unhappy Childhood</i>
86-A	<i>Three-Piece Separation</i>	46	<i>Vega</i>
153	<i>The Trap</i>	46-A	<i>Vega II</i>
12	<i>Triangular Prism</i>	160	<i>Venus</i>
107	<i>Trillium</i>	144	<i>Windmill</i>
79	<i>Triple Cross</i>	98	<i>Yogi Burr</i>